

# Dell Pro 15 Essential

PV15250

Owner's Manual

## Notes, cautions, and warnings

 **NOTE:** A NOTE indicates important information that helps you make better use of your product.

 **CAUTION:** A CAUTION indicates either potential damage to hardware or loss of data and tells you how to avoid the problem.

 **WARNING:** A WARNING indicates a potential for property damage, personal injury, or death.



<b>Chapter 1: Views of Dell Pro 15 Essential PV15250.....</b>	<b>7</b>
Right.....	7
Left.....	7
Top.....	9
Front.....	10
Bottom.....	11
Locate the Service Tag or Express Service Code label of your computer.....	12
Battery-status light.....	13
<b>Chapter 2: Set up your Dell Pro 15 Essential PV15250.....</b>	<b>14</b>
<b>Chapter 3: Specifications of Dell Pro 15 Essential PV15250.....</b>	<b>16</b>
Dimensions and weight.....	16
Processor.....	16
Chipset.....	17
Operating system.....	17
Memory.....	17
External ports and slots.....	18
Internal slots.....	19
Wireless module.....	19
Audio.....	19
Storage.....	20
Media-card reader.....	20
Keyboard.....	21
Keyboard shortcuts of Dell Pro 15 Essential PV15250.....	21
Camera.....	22
Touchpad.....	23
Power adapter.....	23
Battery.....	24
Display.....	25
Fingerprint reader (optional).....	26
GPU—Integrated.....	26
Multiple display support matrix.....	27
Hardware security.....	27
Operating and storage environment.....	27
Dell support policy.....	27
ComfortView.....	28
<b>Chapter 4: Working inside your computer.....</b>	<b>29</b>
Safety instructions.....	29
Before working inside your computer.....	29
Safety precautions.....	30
Electrostatic discharge—ESD protection.....	30
ESD Field Service kit .....	31

Transporting sensitive components.....	32
After working inside your computer.....	32
BitLocker.....	32
BitLocker.....	32
Recommended tools.....	33
Screw list.....	33
Major components of Dell Pro 15 Essential PV15250.....	34
<b>Chapter 5: Removing and installing Customer Replaceable Units (CRUs).....</b>	<b>37</b>
Base cover.....	37
Removing the base cover.....	37
Installing the base cover .....	41
Memory module.....	44
Removing the memory module .....	44
Installing the memory module .....	45
Solid state drive.....	46
Removing the solid state drive .....	46
Installing the solid state drive .....	47
Wireless card.....	48
Removing the wireless card .....	48
Installing the wireless card .....	49
Speakers.....	51
Removing the speakers .....	51
Installing the speakers .....	52
Fan.....	54
Removing the fan .....	54
Installing the fan .....	55
<b>Chapter 6: Removing and installing Field Replaceable Units (FRUs).....</b>	<b>57</b>
Battery.....	57
Rechargeable Li-ion battery precautions.....	57
Removing the 3-cell battery .....	57
Installing the 3-cell battery .....	59
Removing the 4-cell battery .....	60
Installing the 4-cell battery .....	61
Disconnecting the battery cable .....	62
Connecting the battery cable .....	64
Heat sink.....	65
Removing the heat sink.....	65
Installing the heat sink .....	66
Touchpad.....	67
Removing the touchpad .....	67
Installing the touchpad .....	68
I/O daughter-board cable .....	70
Removing the I/O daughter-board cable.....	70
Installing the I/O daughter-board cable.....	70
I/O daughter-board.....	71
Removing the I/O daughter-board .....	71
Installing the I/O daughter-board .....	72

Power button.....	74
Removing the power button .....	74
Installing the power button .....	74
Power button with optional fingerprint reader.....	75
Removing the power button with optional fingerprint reader .....	75
Installing the power button with optional fingerprint reader .....	76
Power-adapter port.....	77
Removing the power-adapter port .....	77
Installing the power-adapter port .....	78
Display assembly.....	79
Removing the display assembly .....	79
Installing the display assembly .....	83
Display hinge caps.....	85
Removing the display hinge caps .....	85
Installing the display hinge caps .....	87
Display bezel.....	89
Removing the display bezel .....	89
Installing the display bezel .....	91
Display hinges.....	92
Removing the display hinges .....	92
Installing the display hinges .....	94
Display panel.....	95
Removing the display panel .....	95
Installing the display panel .....	100
Camera.....	103
Removing the camera.....	103
Installing the camera .....	104
Display cable.....	105
Removing the display cable .....	105
Installing the display cable .....	106
Display back-cover and antenna assembly.....	108
Removing the display back-cover and antenna assembly .....	108
Installing the display back-cover and antenna assembly .....	109
System board.....	110
Removing the system board .....	110
Installing the system board .....	113
Palm-rest and keyboard assembly.....	116
Removing the palm-rest and keyboard assembly .....	116
Installing the palm-rest and keyboard assembly .....	118
<b>Chapter 7: Software.....</b>	<b>122</b>
Operating system.....	122
Drivers and downloads.....	122
<b>Chapter 8: BIOS Setup.....</b>	<b>123</b>
Entering BIOS Setup program.....	123
Navigation keys.....	123
One time boot menu.....	123
System setup options.....	124

Updating the BIOS.....	130
Updating the BIOS in Windows.....	130
Updating the BIOS using the USB drive in Windows.....	131
Updating the BIOS in Linux and Ubuntu.....	132
Updating the BIOS from the One-Time boot menu.....	132
System and setup password.....	132
Assigning a System Setup password.....	132
Deleting or changing an existing system password or setup password.....	133
Clearing system and setup passwords.....	133
<b>Chapter 9: Troubleshooting.....</b>	<b>134</b>
Handling swollen rechargeable Li-ion batteries.....	134
Dell SupportAssist Pre-boot System Performance Check diagnostics.....	134
Running the SupportAssist Pre-Boot System Performance Check.....	135
Built-in self-test (BIST).....	135
Motherboard Built-In Self-Test (M-BIST).....	135
Logic Built-in Self-test (L-BIST).....	136
LCD Built-in Self-Test (LCD-BIST).....	136
System-diagnostic lights.....	136
Recovering the operating system.....	137
Real-Time Clock (RTC Reset).....	138
Backup media and recovery options.....	138
Network power cycle.....	138
Drain flea power (perform hard reset).....	138
<b>Chapter 10: Getting help and contacting Dell.....</b>	<b>140</b>
<b>Chapter 11: Revision history.....</b>	<b>141</b>

# Views of Dell Pro 15 Essential PV15250

## Right



### 1. SD-card slot

Insert an SD card to expand your storage and store photos, videos, and data from your computer. The computer supports the following card types:

- Secure Digital (SD)
- Secure Digital High Capacity (SDHC)
- Secure Digital Extended Capacity (SDXC)

### 2. USB 2.0 (480 Mbps) port

Connect devices such as external storage devices and printers. Supports data transfer speeds up to 480 Mbps.

### 3. Universal Audio port

Connect headphones or a headset (headphone and microphone combo).

## Left

### Left view of computers shipped with plastic chassis



### 1. Power-adaptor port (primary power)

Connect a power adapter to provide power to your computer and charge the battery.

### 2. Power and battery-status light

Indicates the power state and battery state of the computer.

**Solid white**—Power adapter is connected and the battery is charging.

**Solid amber**—Computer is running on battery and the battery charge is low or critical.

**Off**—Power adapter is disconnected or the battery is fully charged.

**NOTE:** On certain computer models, the power and battery-status light are also used for diagnostics. For more information, see the *Troubleshooting* section in this document.

### 3. HDMI 1.4 port

Connect to a TV, external display, or another HDMI-in enabled device. Provides video and audio output.

**NOTE:** The maximum resolution supported by HDMI port is 1920 x 1080 at 60 Hz.

### 4. USB 3.2 Gen 1 (5 Gbps) port

Connect devices such as external storage devices and printers. Provides data transfer speeds up to 5 Gbps.

### 5. USB 3.2 Gen 1 (5 Gbps) Type-C port

Connect devices such as external storage devices and printers. Provides data transfer speeds up to 5 Gbps.

**NOTE:** This USB port does not support video/audio streaming.

## Left view of computers shipped with aluminum chassis



### 1. Power-adaptor port (primary power)

Connect a power adapter to provide power to your computer and charge the battery.

### 2. Power and battery-status light

Indicates the power state and battery state of the computer.

**Solid white**—Power adapter is connected and the battery is charging.

**Solid amber**—Computer is running on battery and the battery charge is low or critical.

**Off**—Power adapter is disconnected or the battery is fully charged.

**NOTE:** On certain computer models, the power and battery-status light are also used for diagnostics. For more information, see the *Troubleshooting* section in this document.

### 3. HDMI 1.4 port

Connect to a TV, external display, or another HDMI-in enabled device. Provides video and audio output.

**NOTE:** The maximum resolution supported by HDMI port is 1920 x 1080 at 60 Hz.

### 4. USB 3.2 Gen 1 (5 Gbps) port

Connect devices such as external storage devices and printers. Provides data transfer speeds up to 5 Gbps.

### 5. USB 3.2 Gen 1 (5 Gbps) Type-C port with Power Delivery/DisplayPort

Connect devices such as external storage devices, printers, and external displays. Provides data transfer speeds up to 5 Gbps.

Supports Power Delivery that enables two-way power supply between devices. Supports up to 15 W power output that enables faster charging.

**NOTE:** A USB Type-C to DisplayPort adapter (sold separately) is required to connect a DisplayPort device.

# Top

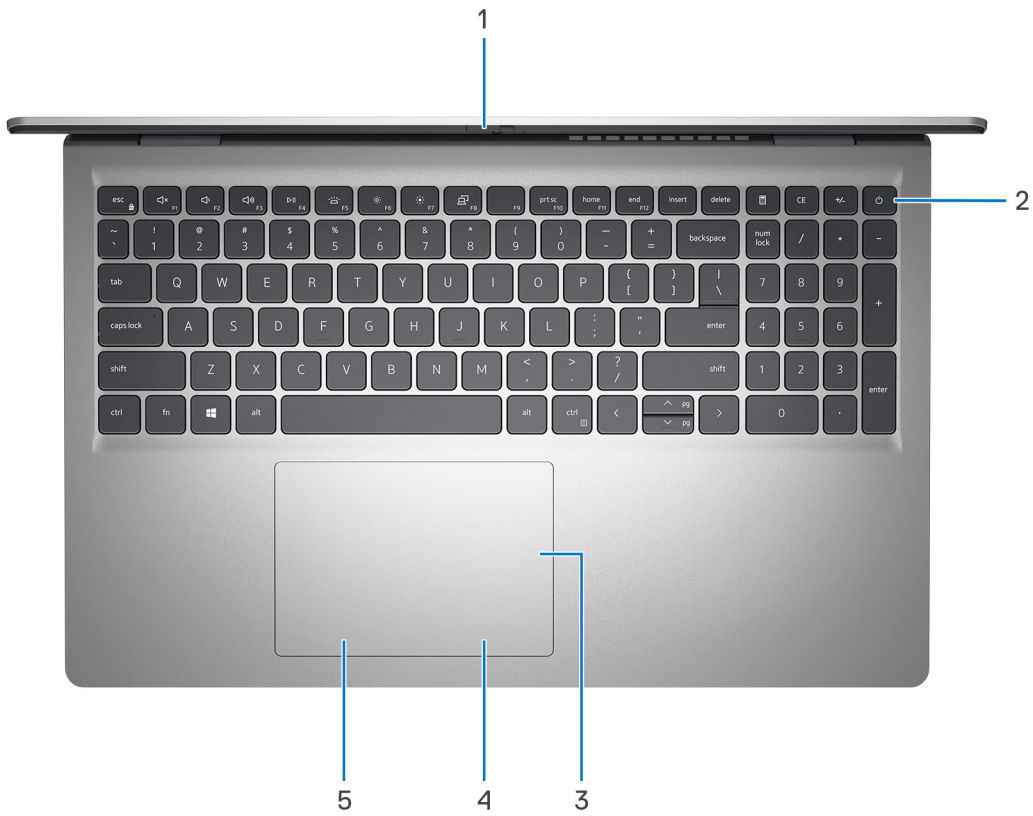

**1. Privacy shutter (only for computers shipped with aluminum chassis)**

Slide the privacy shutter to cover the camera lens and protect your privacy when the camera is not in use.

**2. Power button with optional fingerprint reader**

Press to turn on the computer if it is turned off, in sleep state, or in hibernate state.

When the computer is turned on, press the power button to put the computer into sleep state; press and hold the power button for ten seconds to force shut-down the computer.

If the power button has a fingerprint reader, place your finger on the power button to log in.

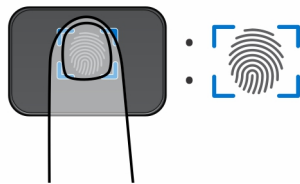

**Figure 1. Active area of the fingerprint reader**

**NOTE:** The highlighted area indicates the actual active fingerprint reader area, and the image is for illustration purposes only.

**NOTE:** You can customize power-button behavior in Windows. For more information, see [Manuals at Dell Support Site](#).

**3. Precision touchpad**

Move your finger on the touchpad to move the mouse pointer. Tap to left-click and two fingers tap to right-click.

**4. Right-click area**

Press to right-click.

**5. Left-click area**

Press to left-click.

## Front

**CAUTION:** The maximum operating angle for the display-panel hinge is 135 degrees.

### Front view of computers shipped with plastic chassis

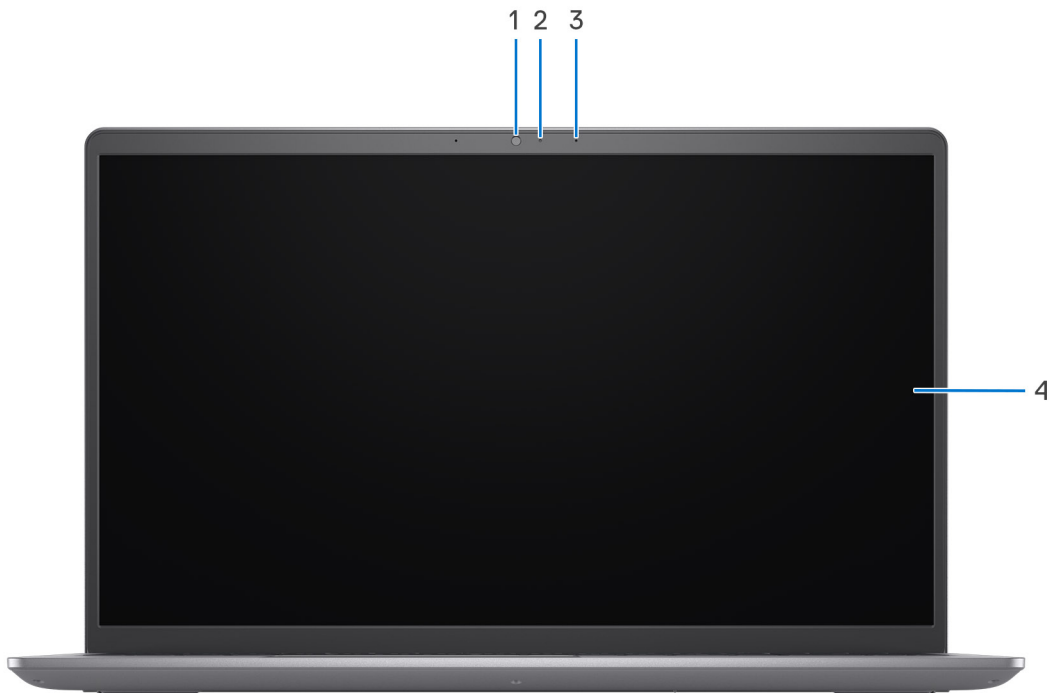

**1. Camera**

Enables you to video chat, capture photos, and record videos.

**2. Camera-status light**

Turns on when the camera is in use.

**3. Microphones**

Provide digital sound input for audio recording and voice calls.

**4. Display**

Provides visual output.

### Front view of computers shipped with aluminum chassis



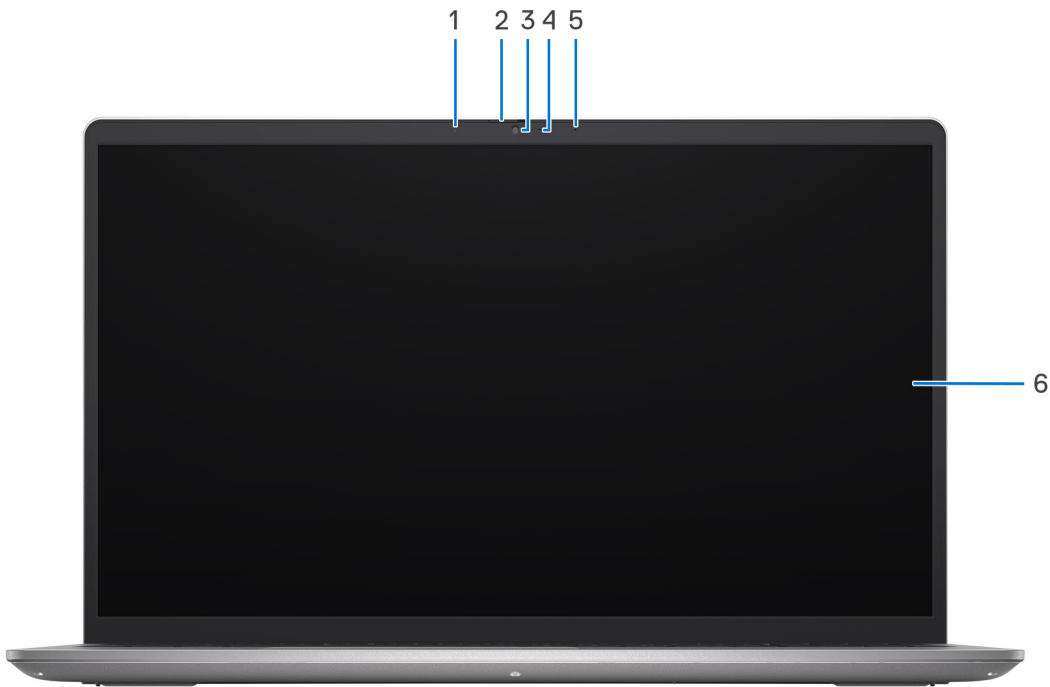

**1. Left microphone**

Provide digital sound input for audio recording and voice calls.

**2. Privacy shutter**

Slide the privacy shutter to cover the camera lens and protect your privacy when the camera is not in use.

**3. Camera**

Enables you to video chat, capture photos, and record videos.

**4. Camera-status light**

Turns on when the camera is in use.

**5. Right microphone**

Provide digital sound input for audio recording and voice calls.

**6. Display**

Provides visual output.

## Bottom

**Bottom view**

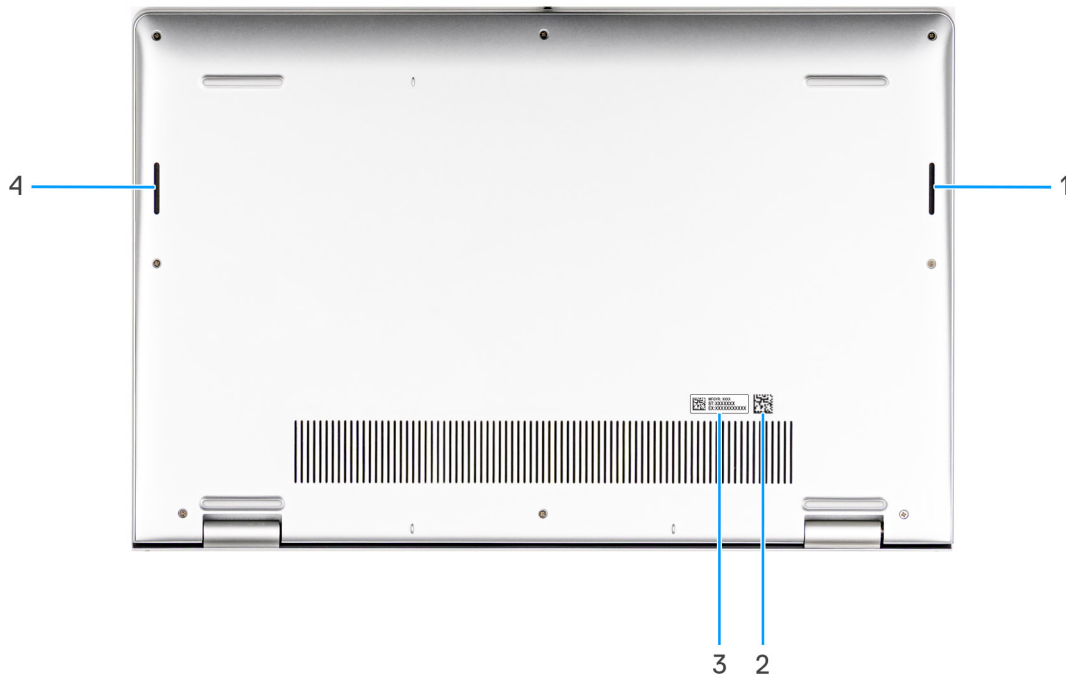

**1. Right speaker**

Provide audio output.

**2. MyDell QR code**

**MyDell** is your hub for content personalized to your Dell Pro 15 Essential PV15250, including videos, articles, manuals, and access to support.

**3. Service Tag/Express Service Code label**

The Service Tag is a unique alphanumeric identifier that enables Dell service technicians to identify the hardware components in your computer and access warranty information. The Express Service Code is a numeric version of the Service Tag.

**4. Left speaker**

Provide audio output.

## Locate the Service Tag or Express Service Code label of your computer

The Service Tag is a unique alphanumeric identifier that allows Dell service technicians to identify the hardware components in your computer and access warranty information. The Express Service Code is a numeric version of the Service Tag.

For more information about how to find the Service Tag of your computer, search in the Knowledge Base Resource at the [Dell Support Site](#).

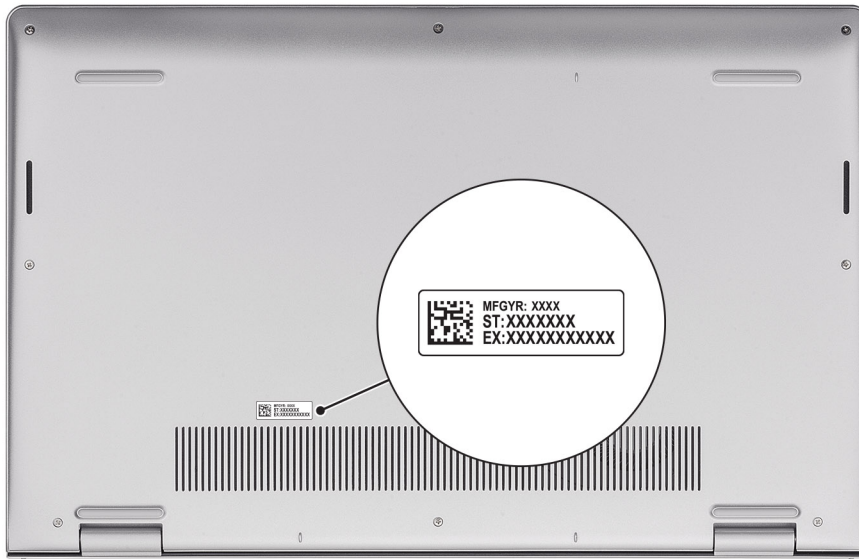

## Battery-status light

The following table lists the battery-status light of your Dell Pro 15 Essential PV15250.

**Table 1. Battery-status light behavior**

Power source	LED behavior	System power state	Battery charge level
AC adapter	Off	S0 or S5	100%
AC adapter	Solid white	S0 or S5	< 100%
Battery	Off	S0 or S5	11-100%
Battery	Solid amber	S0 or S5	< 10%

- S0 (ON): The computer is turned on.
- S3 (Sleep): Screen is off and computer is in sleep mode.
- S4 (Hibernate): The computer consumes the least power in the Hibernate state than in the ON or OFF state. The computer is almost in the OFF state. The context data is written to a storage device, allowing you to resume from where you left after the computer is turned on.
- S5 (OFF): The computer is in a shutdown state.

# Set up your Dell Pro 15 Essential PV15250

## About this task

**NOTE:** The images in this document may differ from your computer depending on the configuration you ordered.

## Steps

1. Connect the power adapter and press the power button.



**NOTE:** The battery may go into power-saving mode during shipment to conserve charge on the battery. Ensure that the power adapter is connected to your computer when it is turned on for the first time.

2. Finish the operating system setup.

### For Ubuntu:

Follow the on-screen instructions to complete the setup. For more information about installing and configuring Ubuntu, search in the Knowledge Base Resource at [Dell Support Site](#).

### For Windows:

Follow the on-screen instructions to complete the setup. When setting up, it is recommended that you:





- Connect to a network for Windows updates.

**NOTE:** If connecting to a secured wireless network, enter the password for the wireless network access when prompted.

- If connected to the Internet, sign-in with an existing Microsoft account or create a new account.
- On the **Support and Protection** screen, enter your contact details.

3. Locate and use Dell apps from the Windows Start menu—Recommended.

**Table 2. Locate Dell apps**

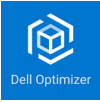
Resources	Description
	<p><b>Dell Product Registration</b> Register your computer with Dell.</p>
	<p><b>Dell Help &amp; Support</b> Access help and support for your computer.</p>
	<p><b>SupportAssist</b> SupportAssist is a proactive and predictive technology that offers automated technical support for Dell computers. It proactively monitors both hardware and software, addressing performance issues, preventing security threats, and automating engagement with Dell Technical Support. For more information, see the SupportAssist documentation at <a href="#">Dell Support Site</a>.</p> <p> <b>NOTE:</b> In SupportAssist, click the warranty expiry date to renew or upgrade your warranty.</p>
	<p>Dell Optimizer is an application designed to enhance computer performance and productivity by optimizing settings for power, battery, display, collaboration touchpad, and presence detection. It also provides access to applications purchased with your new computer. For more information, see Dell Optimizer User's Guide at <a href="#">Dell Support Site</a>.</p>

# Specifications of Dell Pro 15 Essential PV15250

## Dimensions and weight

The following table lists the height, width, depth, and weight of your Dell Pro 15 Essential PV15250.

**Table 3. Dimensions and weight**

Description	Computer shipped with plastic chassis	Computer shipped with aluminum chassis
Height:		
Front height	16.96 mm (0.67 in.)	15.52 mm (0.61 in.)
Rear height	18.99 mm (0.75 in.)	17.50 mm (0.69 in.)
Width	358.50 mm (14.11 in.)	358.50 mm (14.11 in.)
Depth	235.56 mm (9.27 in.)	234.90 mm (9.25 in.)
Weight (maximum) <span data-bbox="108 1077 140 1167">i</span> <b>NOTE:</b> The weight of your computer depends on the configuration that is ordered.	1.90 kg (4.19 lb)	1.94 kg (4.28 lb)

## Processor

The following table lists the details of the processors that are supported in your Dell Pro 15 Essential PV15250.

**Table 4. Processor**

Description	Option one	Option two	Option three
Processor type	13th Gen Intel Core i5-1334U	13th Gen Intel Core i7-1355U	Intel Core 3 100U
Processor wattage	15 W	15 W	15 W
Processor total core count	10	10	6
Performance-cores	2	2	2
Efficient-cores	8	8	4
Processor total thread counts <span data-bbox="108 1832 140 1921">i</span> <b>NOTE:</b> Intel Hyper-Threading Technology is only available on Performance-cores.	12	12	8
Processor speed	Up to 4.6 GHz	Up to 5 GHz	Up to 4.7 GHz

**Table 4. Processor (continued)**

Description		Option one	Option two	Option three
Performance-cores frequency				
	Processor base frequency	1.3 GHz	1.7 GHz	1.2 GHz
	Maximum turbo frequency	4.6 GHz	5 GHz	4.7 GHz
Efficient-cores frequency				
	Processor base frequency	0.9 GHz	1.2 GHz	0.9 GHz
	Maximum turbo frequency	3.4 GHz	3.7 GHz	3.3 GHz
Processor cache		12 MB	12 MB	10 MB
Integrated graphics		Intel Iris X <sup>e</sup> Graphics	Intel Iris X <sup>e</sup> Graphics	Intel Graphics

## Chipset

The following table lists the details of the chipset that is supported by your Dell Pro 15 Essential PV15250.

**Table 5. Chipset**

Description	Option one	Option two
Processors	Intel Core 3 100U	13th Gen Intel Core i5/i7 processors
Chipset	Integrated with the processor	Integrated with the processor
DRAM bus width	64-bit	64-bit
Flash EPROM	32 MB	32 MB
PCIe bus	Up to Gen3	Up to Gen3/Gen4

## Operating system

Your Dell Pro 15 Essential PV15250 supports the following operating systems:

- Windows 11 Pro
- Windows 11 Pro National Academic
- Windows 11 Home
- Windows 11 Home (S mode)
- Ubuntu Linux 22.04 LTS, 64-bit

## Memory

The following table lists the memory specifications of your Dell Pro 15 Essential PV15250.

**Table 6. Memory specifications**

Description	Values
Memory slots	SODIMM

**Table 6. Memory specifications (continued)**

Description	Values
Memory type	DDR5
Memory speed	<ul style="list-style-type: none"> <li>4400 MT/s (for computers shipped with USB 3.2 Gen 1 (5 Gbps) Type-C port (data only))</li> <li>5200 MT/s (for computers shipped with USB 3.2 Gen 1 (5 Gbps) Type-C port with DisplayPort Alt Mode 1.4/Power Delivery)</li> </ul>
Maximum memory configuration	16 GB
Minimum memory configuration	8 GB
Memory size per slot	8 GB or 16 GB
Memory configurations supported	<p><b>For computers shipped with USB 3.2 Gen 1 (5 Gbps) Type-C port (data only)</b></p> <ul style="list-style-type: none"> <li>8 GB: 1 x 8 GB, DDR5, 4400 MT/s</li> <li>16 GB: 1 x 16 GB, DDR5, 4400 MT/s</li> </ul> <p><b>For computers shipped with USB 3.2 Gen 1 (5 Gbps) Type-C port with DisplayPort Alt Mode 1.4/Power Delivery</b></p> <ul style="list-style-type: none"> <li>8 GB: 1 x 8 GB, DDR5, 5200 MT/s</li> <li>16 GB: 1 x 16 GB, DDR5, 5200 MT/s</li> </ul>

## External ports and slots

The following table lists the external ports and slots on your Dell Pro 15 Essential PV15250.

**Table 7. External ports and slots**

Description	Values
USB ports	<ul style="list-style-type: none"> <li>One USB 3.2 Gen 1 (5 Gbps) port</li> <li>One USB 2.0 (480 Mbps) port</li> <li>One USB 3.2 Gen 1 (5 Gbps) Type-C port (only for computers with plastic chassis)</li> <li>One USB 3.2 Gen 1 (5 Gbps) Type-C port with DisplayPort Alt Mode 1.4/Power Delivery (only for computers with aluminum chassis)</li> </ul>
Audio port	One Universal Audio port
Video port(s)	<ul style="list-style-type: none"> <li>One HDMI 1.4 port</li> </ul> <p> <b>NOTE:</b> The maximum resolution supported by HDMI port is 1920 x 1080 at 60 Hz.</p> <ul style="list-style-type: none"> <li>One USB 3.2 Gen 1 (5 Gbps) Type-C port with DisplayPort Alt Mode 1.4/Power Delivery (only for computers with aluminum chassis)</li> </ul>
Media-card reader	One SD-card slot
Power-adaptor port	One DC-in port (4.50 mm standard plug)
Security-cable slot	Not supported



## Internal slots

The following table lists the internal slots of your Dell Pro 15 Essential PV15250.

**Table 8. Internal slots**

Description	Values
M.2	<ul style="list-style-type: none"> <li>One M.2 Key-M (2230/2280) slot for solid state drive</li> <li>One M.2 2230 Key-E slot for Wi-Fi and Bluetooth combo card</li> </ul> <p> <b>NOTE:</b> To learn more about the features of different types of M.2 cards, search <a href="#">Dell Support Site</a>.</p>

## Wireless module

The following table lists the Wireless Local Area Network (WLAN) modules that are supported on your Dell Pro 15 Essential PV15250.

**Table 9. Wireless module specifications**

Description	Option one	Option two
Model number	Realtek RTL8821CE	Realtek RTL8852BE
Transfer rate	Up to 433 Mbps	Up to 1201 Mbps
Frequency bands supported	2.40 GHz/5 GHz	2.40 GHz/5 GHz
Wireless standards	<ul style="list-style-type: none"> <li>WiFi 802.11a/b/g</li> <li>Wi-Fi 4 (WiFi 802.11n)</li> <li>Wi-Fi 5 (WiFi 802.11ac)</li> </ul>	<ul style="list-style-type: none"> <li>WiFi 802.11a/b/g</li> <li>Wi-Fi 4 (WiFi 802.11n)</li> <li>Wi-Fi 5 (WiFi 802.11ac)</li> <li>Wi-Fi 6 (WiFi 802.11ax)</li> </ul>
Encryption	<ul style="list-style-type: none"> <li>64-bit/128-bit WEP</li> <li>AES-CCMP</li> <li>TKIP</li> </ul>	<ul style="list-style-type: none"> <li>64-bit/128-bit WEP</li> <li>AES-CCMP</li> <li>TKIP</li> </ul>
Bluetooth wireless card  <b>NOTE:</b> The functionality of the Bluetooth wireless card may vary based on the operating system.	Bluetooth 5.0 wireless card	Bluetooth 5.3 wireless card

## Audio

The following table lists the audio specifications of your Dell Pro 15 Essential PV15250.

**Table 10. Audio specifications**

Description	Values
Audio controller	There are two audio controller options: <ul style="list-style-type: none"> <li>Realtek ALC3204</li> <li>Realtek ALC3254</li> </ul>
Stereo conversion	Supported

**Table 10. Audio specifications (continued)**

Description		Values
Internal audio interface		High Definition Audio interface
External audio interface		One Universal Audio port
Number of speakers		Two
Internal-speaker amplifier		Supported
External volume controls		Keyboard shortcut controls
Speaker output:		
	Average	2 W x 2 = 4 W
	Peak	2.5 W x 2 = 5 W
Microphone		<ul style="list-style-type: none"> <li>• Single integrated microphone (for computers shipped with plastic chassis)</li> <li>• Dual-array microphones (for computers shipped with aluminum chassis)</li> </ul>

## Storage

This section lists the storage options on your Dell Pro 15 Essential PV15250.

Your Dell Pro 15 Essential PV15250 supports one M.2 2230 solid state drive. The M.2 2230 solid state drive is the primary storage drive of your computer.

**Table 11. Storage specifications**

Storage type	Interface type	Capacity
M.2 2230 solid state drive	PCIe NVMe Gen4 x4	Up to 1 TB

## Media-card reader

The following table provides the specification of media cards that are supported by your Dell Pro 15 Essential PV15250.

**Table 12. Media-card reader specifications**

Description	Values
Media-card slot type	One SD-card slot
Media-cards supported	<ul style="list-style-type: none"> <li>• Secure Digital (SD)</li> <li>• Secure Digital High Capacity (SDHC)</li> <li>• Secure Digital Extended Capacity (SDXC)</li> </ul>
<p><b>NOTE:</b> The maximum capacity of the media-card reader varies depending on the standard of the media card that is inserted in your computer.</p>	

# Keyboard

The following table lists the keyboard specifications of your Dell Pro 15 Essential PV15250.

**Table 13. Keyboard specifications**

Description	Values
Keyboard type	<ul style="list-style-type: none"> <li>Standard backlit keyboard</li> <li>Standard non-backlit keyboard</li> </ul>
Keyboard layout	QWERTY
Number of keys	<ul style="list-style-type: none"> <li>Arabic, Canada (Bilingual) (MUI), English International, English US, Greek, Hebrew, Russian, Thai, Ukrainian: 99 keys</li> <li>Belgian, Bulgarian, Czech/Slovak (MUI), English UK, French (European), German, Hungarian, Italian, Portuguese, Slovenian, Spanish (Castilian), Spanish (Latin America), Swiss/European (MUI), Turkish: 100 keys</li> <li>Japanese: 103 keys</li> </ul>
Key pitch	X = 18.70 mm Y = 18.05 mm
Keyboard shortcuts	<p>Some keys on your keyboard have two symbols on them. These keys can be used to type alternate characters or to perform secondary functions.</p> <ul style="list-style-type: none"> <li>To type the alternate character, press Shift and the desired key.</li> <li>To perform secondary functions, press Fn and the desired key.</li> </ul> <p><b>i</b> <b>NOTE:</b> You can define the primary behavior of the function keys (F1–F12) by changing <b>Function Key Behavior</b> in the BIOS Setup program.</p> <p><b>i</b> <b>NOTE:</b> If Copilot in Windows is not available on your computer, pressing the Copilot key launches Windows search. For more information about Copilot in Windows, see the Knowledge Base Resource at the <a href="#">Dell Support site</a>.</p>

## Keyboard shortcuts of Dell Pro 15 Essential PV15250

**i** **NOTE:** Keyboard characters may differ depending on the keyboard language configuration. Keys that are used for shortcuts remain the same across all language configurations.

Some keys on your keyboard have two symbols on them. These keys can be used to type alternate characters or to perform secondary functions. The symbol that is shown on the lower part of the key refers to the character that is typed out when the key is pressed. If you press shift and the key, the symbol that is shown on the upper part of the key is typed out. For example, if you press **2**, 2 is typed out; if you press **Shift + 2**, @ is typed out.

The keys F1-F12 at the top row of the keyboard are function keys for multimedia control, as indicated by the icon on the key. Press the function key to enable the task represented by the icon. For example, pressing F1 mutes the audio (see the table below).

However, if the function keys F1-F12 are needed for specific software applications, multimedia functionality can be disabled by pressing **Fn + Esc**. Later, multimedia control can be invoked by pressing **Fn** and the respective function key. For example, mute audio by pressing **Fn + F1**.

 **NOTE:** You can also define the primary behavior of the function keys (F1–F12) by changing **Function Key Behavior** in the BIOS setup program.

**Table 14. Function key primary behavior**

Function key	Primary behavior
F1	Mute or unmute audio
F2	Decrease volume
F3	Increase volume
F4	Play or Pause
F5	Keyboard illumination/backlight  <b>NOTE:</b> Non-backlight keyboards have F5 function key without the backlight icon and do not support toggle keyboard backlight function.
F6	Decrease brightness
F7	Increase brightness
F8	Switch to external display
F10	Print screen
F11	Home
F12	End

The **Fn** key is also used with selected keys on the keyboard to invoke different functions.

**Table 15. Secondary behavior**

Function key	Secondary behavior
Fn + <b>F1</b> to <b>F12</b>	Operating system or application-specific behavior
Fn + Ctrl	Open the application menu
Fn + Esc	Toggle between multimedia and function key behavior
Fn + PgUp	Scroll up the document or page
Fn + PgDn	Scroll down the document or page
Fn + Home	Move to the beginning of the document
Fn + End	Move to the end of the document

## Camera

The following table lists the camera specifications of your Dell Pro 15 Essential PV15250.

**Table 16. Camera specifications**

Description	Computer shipped with plastic chassis	Computer shipped with aluminum chassis
Number of cameras	One	One
Camera type	HD RGB camera	FHD RGB camera
Camera location	Front camera	Front camera
Camera sensor type	CMOS sensor technology	CMOS sensor technology
Camera resolution:		

**Table 16. Camera specifications (continued)**

Description		Computer shipped with plastic chassis	Computer shipped with aluminum chassis
	Still image	0.92 megapixel	2.00 megapixel
	Video	1280 x 720 (HD) at 30 fps	1920 x 1080 (FHD) at 30 fps
Diagonal viewing angle		83.50 degrees	86.30 degrees

## Touchpad

The following table lists the touchpad specifications of your Dell Pro 15 Essential PV15250.

**Table 17. Touchpad specifications**

Description		Values
Touchpad resolution:		
	Horizontal	> 300 dpi
	Vertical	> 300 dpi
Touchpad dimensions:		
	Horizontal	115.00 mm (4.53 in.)
	Vertical	80.00 mm (3.15 in.)
Touchpad gestures		For more information about the touchpad gestures available on Windows, search <a href="#">Microsoft Support Site</a> .

## Power adapter

The following table lists the power adapter specifications of your Dell Pro 15 Essential PV15250.

**Table 18. Power-adapter specifications**

Description		Values
Type		65 W
Connector dimensions:		
	External diameter	4.50 mm (0.18 in.)
	Internal diameter	2.90 mm (0.11 in.)
Power-adapter dimensions:		
	Height	28.00 mm (1.10 in.)
	Width	47.00 mm (1.90 in.)
	Depth	108.00 mm (4.30 in.)
Power-adapter weight (maximum)		0.29 kg (0.64 lb)
Input voltage		100 VAC - 240 VAC



**Table 18. Power-adapter specifications (continued)**

Description		Values
Input frequency		50 Hz - 60 Hz
Input current (maximum)		1.60 A/1.70 A
Output current (continuous)		3.34 A
Rated output voltage		19.50 VDC
Temperature range:		
	Operating	0°C to 40°C (32°F to 104°F)
	Storage	-40°C to 70°C (-40°F to 158°F)
 <b>CAUTION:</b> Operating and storage temperature ranges may differ among components, so operating or storing the device outside these ranges may impact the performance of specific components.		

## Battery

The following table lists the battery specifications of your Dell Pro 15 Essential PV15250.

**Table 19. Battery specifications**

Description		Option one	Option two
Battery type		3-cell, 41 Wh, Lithium Ion Polymer, ExpressCharge	4-cell, 54 Wh, Lithium Ion Polymer, ExpressCharge
Battery voltage		11.25 VDC	15.00 VDC
Battery weight (maximum)		0.19 kg (0.41 lb)	0.24 kg (0.55 lb)
Battery dimensions:			
	Height	206.40 mm (8.12 in.)	271.90 mm (10.70 in.)
	Width	82.00 mm (3.22 in.)	82.00 mm (3.22 in.)
	Depth	5.75 mm (0.22 in.)	5.75 mm (0.22 in.)
Temperature range:			
	Operating	When charging battery: <ul style="list-style-type: none"> <li>Initiating charging: 0°C to 45°C (32°F to 113°F)</li> <li>Upper limit for charging (maximum): 50°C (122°F)</li> </ul> When discharging battery: <ul style="list-style-type: none"> <li>Normal discharging: 0°C to 60°C (32°F to 140°F)</li> <li>Over temperature protection (maximum): 70°C (158°F)</li> </ul>  <b>NOTE:</b> The battery does not allow discharge past this temperature.	When charging battery: <ul style="list-style-type: none"> <li>Initiating charging: 0°C to 45°C (32°F to 113°F)</li> <li>Upper limit for charging (maximum): 50°C (122°F)</li> </ul> When discharging battery: <ul style="list-style-type: none"> <li>Normal discharging: 0°C to 60°C (32°F to 140°F)</li> <li>Over temperature protection (maximum): 70°C (158°F)</li> </ul>  <b>NOTE:</b> The battery does not allow discharge past this temperature.

**Table 19. Battery specifications (continued)**

Description		Option one	Option two
	Storage	-20°C to 60°C (-4°F to 140°F)	-20°C to 60°C (-4°F to 140°F)
Battery operating time		Varies depending on operating conditions and can significantly reduce under certain power-intensive conditions	Varies depending on operating conditions and can significantly reduce under certain power-intensive conditions
Battery charging time (approximate) <b>i</b> <b>NOTE:</b> You can control the charging time, duration, start and end time, and so on, using the settings on the MyDell (replaced with Dell Optimizer) application (Power option). For more information about MyDell application, search <a href="#">Dell Support Site</a> .		<b>Standard Charge/Predominately AC User Charge Method:</b> <ul style="list-style-type: none"> <li>0 - 15°C maximum allowable charge time from 0 to 100% RSOC is 4 hours</li> <li>16 - 50°C maximum allowable charge time from 0 to 100% RSOC is 3 hours</li> </ul> <b>Express Charge Method:</b> <ul style="list-style-type: none"> <li>0 - 15°C maximum allowable charge time from 0 to 100% RSOC is 4 hours</li> <li>16 - 45°C normal express charge</li> <li>46 - 50°C maximum allowable charge time from 0 to 100% RSOC is 3 hours</li> </ul>	<b>Standard Charge/Predominately AC User Charge Method:</b> <ul style="list-style-type: none"> <li>0 - 15°C maximum allowable charge time from 0 to 100% RSOC is 4 hours</li> <li>16 - 50°C maximum allowable charge time from 0 to 100% RSOC is 3 hours</li> </ul> <b>Express Charge Method:</b> <ul style="list-style-type: none"> <li>0 - 15°C maximum allowable charge time from 0 to 100% RSOC is 4 hours</li> <li>16 - 45°C normal express charge</li> <li>46 - 50°C maximum allowable charge time from 0 to 100% RSOC is 3 hours</li> </ul>
Coin-cell battery		Not supported	Not supported
<b>⚠ CAUTION: Operating and storage temperature ranges may differ among components, so operating or storing the device outside these ranges may impact the performance of specific components.</b>			
<b>⚠ CAUTION: Dell Technologies recommends that you charge the battery regularly for optimal power consumption.</b>			

## Display

The following table lists the display specifications of your Dell Pro 15 Essential PV15250.

**Table 20. Display specifications**

Description		Option one	Option two	Option three
Display type		15.6" Full High Definition (FHD)	15.6" Full High Definition (FHD)	TBD
Touch options		No	Yes	TBD
Display-panel technology		In-Plane Switching (IPS)	In-Plane Switching (IPS)	TBD
Display-panel dimensions (active area):				
	Height	193.59 mm (7.62 in.)	193.59 mm (7.62 in.)	TBD
	Width	344.16 mm (13.55 in.)	344.16 mm (13.55 in.)	TBD
	Diagonal	394.87 mm (15.55 in.)	394.87 mm (15.55 in.)	TBD
Display-panel native resolution		1920 x 1080	1920 x 1080	TBD

**Table 20. Display specifications (continued)**

Description	Option one	Option two	Option three
Luminance (typical)	250 nits	220 nits	___ nits
Megapixels	2.07	2.07	TBD
Color gamut	45% NTSC	45% NTSC	TBD
Pixels Per Inch (PPI)	141	141	TBD
Contrast ratio (typical)	600:1	700:1	TBD
Response time (maximum)	35 ms	35 ms	___ ms
Refresh rate	120 Hz	60 Hz	___ Hz
Horizontal view angle	80 +/- degrees (minimum)	80 +/- degrees (minimum)	TBD
Vertical view angle	80 +/- degrees (minimum)	80 +/- degrees (minimum)	TBD
Pixel pitch	0.17925 mm x 0.17925 mm	0.17925 mm x 0.17925 mm	TBD
Power consumption (maximum)	5.25 W	4.10 W	___ W
Anti-glare vs glossy finish	Anti-Glare	Anti-Glare	TBD

## Fingerprint reader (optional)

The following table lists the specifications of the optional fingerprint reader of your Dell Pro 15 Essential PV15250.

 **NOTE:** The fingerprint reader is on the power button.

**Table 21. Fingerprint reader specifications**

Description	Values
Sensor technology	Capacitive sensing
Sensor resolution	500 dpi
Sensor pixel size	108 x 88 pixels

## GPU—Integrated

The following table lists the specifications of the integrated Graphics Processing Unit (GPU) supported by your Dell Pro 15 Essential PV15250.

**Table 22. GPU—Integrated**

Controller	Memory size	Processor
Intel Graphics	Shared system memory	Intel Core 3 100U processor
Intel Iris X <sup>e</sup> Graphics/Intel UHD Graphics	Shared system memory (dual-channel)	13th Gen Intel Core i5/i7 processors



## Multiple display support matrix

The following table lists the multiple display support matrix for your Dell Pro 15 Essential PV15250.

**Table 23. Multiple display support matrix**

Graphics Card	Direct Graphics Controller Direct Output Mode	Supported external displays with computer internal display on	Supported external displays with computer internal display off
Intel Graphics	Not supported	2	1
Intel Iris X <sup>e</sup> Graphics/ Intel UHD Graphics	Not supported	3	2

## Hardware security

The following table lists the hardware security of your Dell Pro 15 Essential PV15250.

**Table 24. Hardware security**

Hardware security
Windows Hello - Fingerprint Reader (optional)
Trusted Platform Module TPM 2.0

## Operating and storage environment

This table lists the operating and storage specifications of your Dell Pro 15 Essential PV15250.

**Airborne contaminant level:** G1 as defined by ISA-S71.04-1985

**Table 25. Computer environment**

Description	Operating	Storage
Temperature range	0°C to 35°C (32°F to 95°F)	-40°C to 65°C (-40°F to 149°F)
Relative humidity (maximum)	10% to 90% (non-condensing)	0% to 95% (non-condensing)
Vibration (maximum)*	0.66 GRMS	1.30 GRMS
Shock (maximum)	110 G†	160 G†
Altitude range	0 m to 3048 m (0 ft to 10000 ft)	0 m to 10668 m (0 ft to 35000 ft)
 <b>CAUTION: Operating and storage temperature ranges may differ among components, so operating or storing the device outside these ranges may impact the performance of specific components.</b>		

\* Measured using a random vibration spectrum that simulates the user environment.

† Measured using a 2 ms half-sine pulse.

## Dell support policy

For information about Dell support policy, search [Dell Support Site](#).

# ComfortView

 **WARNING: Prolonged exposure to blue light from the display may lead to long-term effects such as eye strain, eye fatigue, or damage to the eyes.**

Blue light is a color in the light spectrum which has a short wavelength and high energy. Chronic exposure to blue light, particularly from digital sources, may disrupt sleep patterns and cause long-term effects such as eye strain, eye fatigue, or damage to the eyes.

Dell ComfortView software technology reduces harmful blue light emissions to make extended screen time easy on your eyes.

ComfortView mode can be enabled and configured using the Dell CinemaColor application.

ComfortView mode complies with TÜV Rheinland's requirement for low blue light displays.











To reduce the risk of eye strain, it is also recommended that you:

- Position the display at a comfortable viewing distance between 20 and 28 inches (50 cm and 70 cm) from your eyes.
- Blink frequently to moisten your eyes, wet your eyes with water, or apply suitable eye drops.
- Take an extended break for 20 minutes every two hours.
- Look away from your display, and gaze at a distant object at 20 ft (609.60 cm) away for at least 20 seconds during each break.

# Working inside your computer



## Safety instructions

Use the following safety guidelines to protect your computer from potential damage and to ensure your personal safety. Unless otherwise noted, each procedure in this document assumes that you have read the safety information that shipped with your computer.

-  **WARNING:** Before working inside your computer, read the safety information that is shipped with your computer. For more safety best practices, see [Dell Regulatory Compliance Home Page](#).
-  **WARNING:** Disconnect your computer from all power sources before opening the computer cover or panels. After you finish working inside the computer, replace all covers, panels, and screws before connecting your computer to an electrical outlet.
-  **WARNING:** For laptops, discharge the battery completely before removing it. Disconnect the AC power adapter from the computer and operate the computer solely on battery power—the battery is fully discharged when the computer no longer turns on when the power button is pressed.
-  **CAUTION:** To avoid damaging the computer, ensure that the work surface is flat, dry, and clean.
-  **CAUTION:** You should only perform troubleshooting and repairs as authorized or directed by the Dell technical support team. Damage due to servicing that is not authorized by Dell is not covered by your warranty.
-  **CAUTION:** Before touching anything inside your computer, ground yourself by touching an unpainted metal surface, such as the metal at the back of the computer. While you work, periodically touch an unpainted metal surface to dissipate static electricity which could harm internal components.
-  **CAUTION:** To avoid damaging the components and cards, handle them by their edges, and avoid touching the pins and the contacts.
-  **CAUTION:** When you disconnect a cable, pull it by its connector or its pull tab, not the cable itself. Some cables have connectors with locking tabs or thumbscrews that you must disengage before disconnecting the cable. When disconnecting cables, keep them evenly aligned to avoid bending the connector pins. When connecting cables, ensure that the connector on the cable is correctly oriented and aligned with the port.
-  **CAUTION:** Press and eject any installed card from the media-card reader.
-  **CAUTION:** Exercise caution when handling rechargeable Li-ion batteries in laptops. Swollen batteries should not be used and should be replaced and disposed properly.

## Before working inside your computer

### Steps

1. Save and close all open files and exit all open applications.
2. Shut down your computer. For Windows operating system, click **Start** >  **Power** > **Shut down**.  
 **NOTE:** If you are using a different operating system, see the documentation of your operating system for shut-down instructions.
3. Disconnect your computer and all attached devices from their electrical outlets.
4. Disconnect all attached network devices and peripherals, such as keyboard, mouse, and monitor from your computer.
5. Remove any media card and optical disk from your computer, if applicable.

6. Enter the service mode, if you are able to power on your computer.

### Service Mode

Service Mode is used to cut-off power, without disconnecting battery cable from system board prior conducting repairs in the computer.

**CAUTION:** If you are unable to turn on the computer to put it into Service Mode or the computer does not support Service Mode then proceed to disconnect the battery cable. To disconnect the battery cable, follow the steps in [Removing the battery](#).

**NOTE:** Ensure that your computer is shut down and the AC adapter is disconnected.

- a. Hold **<B>** key on the keyboard and press the power button for 3 seconds or until the Dell logo appears on the screen.
- b. Press any key to continue.
- c. If the AC adapter is not disconnected, a message prompting you to remove the AC adapter appears on the screen. Remove the AC adapter and then press any key to continue the **Service Mode** procedure. The **Service Mode** procedure automatically skips the following step if the **Owner Tag** of the computer is not set up in advance by the user.
- d. When the ready-to-proceed message appears on the screen, press any key to proceed. The computer emits three short beeps and shuts down immediately.
- e. Once the computer shuts down, it has successfully entered Service Mode.

**NOTE:** If you are unable to power on your computer or unable to enter service mode skip this process.

## Safety precautions

This section details the primary steps to be followed before disassembling any device or component.

Observe the following safety precautions before any installation or break-fix procedures involving disassembly or reassembly:

- Turn off the computer and all attached peripherals.
- Disconnect the computer from AC power.
- Disconnect all network cables and peripherals from the computer.
- Use an ESD field service kit when working inside your computer to avoid electrostatic discharge (ESD) damage.
- Place the removed component on an anti-static mat after removing it from the computer.
- Press and hold the power button for 15 seconds to discharge the residual power in the system board.

## Bonding

Bonding is a method for connecting two or more grounding conductors to the same electrical potential. This is done by using a field service electrostatic discharge (ESD) kit. When connecting a bonding wire, ensure that it is connected to bare metal and never to a painted or nonmetal surface. Ensure that the wrist strap is secure and in full contact with your skin. Remove all jewelry, watches, bracelets, or rings before grounding yourself and the equipment.

## Electrostatic discharge—ESD protection

ESD is a major concern when you handle electronic components, especially sensitive components such as expansion cards, processors, memory modules, and system boards. A slight charge can damage circuits in ways that may not be obvious, such as intermittent problems or a shortened product life span. As the industry pushes for lower power requirements and increased density, ESD protection is an increasing concern.

Two recognized types of ESD damage are catastrophic and intermittent failures.

- **Catastrophic** – Catastrophic failures represent approximately 20 percent of ESD-related failures. The damage causes an immediate and complete loss of device functionality. An example of catastrophic failure is a memory module that has received a static shock and immediately generates a "No POST/No Video" symptom with a beep code that is emitted for missing or nonfunctional memory.
- **Intermittent** – Intermittent failures represent approximately 80 percent of ESD-related failures. The high rate of intermittent failures means that most of the time when damage occurs, it is not immediately recognizable. The memory module receives a static shock, but the tracing is merely weakened and does not immediately produce outward symptoms that are related to the damage. The weakened trace may take weeks or months to melt, and in the meantime may cause degradation of memory integrity, intermittent memory errors, and so on.

Intermittent failures that are also called latent or "walking wounded" are difficult to detect and troubleshoot.

Perform the following steps to prevent ESD damage:

- Use a wired ESD wrist strap that is properly grounded. Wireless anti-static straps do not provide adequate protection. Touching the chassis before handling parts does not ensure adequate ESD protection on parts with increased sensitivity to ESD damage.
- Handle all static-sensitive components in a static-safe area. If possible, use anti-static floor pads and workbench pads.
- When unpacking a static-sensitive component from its shipping carton, do not remove the component from the anti-static packing material until you are ready to install the component. Before unwrapping the anti-static packaging, use the anti-static wrist strap to discharge the static electricity from your body.

**i NOTE:** You can protect against ESD and discharge static electricity from your body by touching a metal-grounded object before you interact with anything electronic, for example, an unpainted metal surface on your computer's I/O panel. When connecting a peripheral (including handheld digital assistants) to your computer, you should always ground both yourself and the peripheral before connecting it to the computer. In addition, as you work inside the computer, periodically touch a metal-grounded object to remove any static charge that your body may have accumulated.

For more information about the wrist strap and ESD wrist strap tester, see [Components of an ESD Field Service Kit](#).

- Before transporting a static-sensitive component, place it in an anti-static container or packaging.

## ESD Field Service kit

The unmonitored field service kit is the most commonly used service kit. Each Field Service kit includes three main components: anti-static mat, wrist strap, and bonding wire.

**⚠ CAUTION:** It is critical to keep ESD-sensitive devices away from internal parts that are insulated and often highly charged, such as plastic heat sink casings.

## Working environment

Before the ESD Field Service kit is deployed, conduct an evaluation of the site to ensure proper setup and readiness. For example, deploying the kit for a server environment is different than for a desktop or laptop environment. Servers are typically installed in a rack within a data center; desktops or laptops are typically placed on office desks or cubicles. Always look for a large open flat work area that is free of clutter and large enough to deploy the ESD kit with additional space to accommodate the type of computer that is being repaired. The workspace should also be free of insulators that can cause an ESD event. On the work area, insulators such as styrofoam and other plastics should always be moved at least 12 inches or 30 centimeters away from sensitive parts before physically handling any hardware components.

## ESD packaging

All ESD-sensitive devices must be shipped and received in static-safe packaging. Metal, static-shielded bags are preferred. However, you should always return the damaged component using the same ESD bag and packaging that the new part arrived in. The ESD bag should be folded over and taped shut and all the same foam packing material should be used in the original box that the new part arrived in. ESD-sensitive devices should be removed from packaging only at an ESD-protected work surface, and parts should never be placed on top of the ESD bag because only the inside of the bag is shielded. Always place parts in your hand, on the anti-static mat, in the computer, or inside an ESD bag.

## Components of an ESD Field Service kit

The components of an ESD Field Service kit are:

- **Anti-Static Mat** – The anti-static mat is dissipative and parts can be placed on it during service procedures. When using an anti-static mat, your wrist strap should be snug and the bonding wire should be connected to the anti-static mat and to any bare metal on the computer being worked on. Once deployed properly, service parts can be removed from the ESD bag and placed directly on the anti-static mat. ESD-sensitive items are safe in your hand, on the anti-static mat, in the computer, or inside an ESD bag.
- **Wrist Strap and Bonding Wire** – If an anti-static mat is not being used, the wrist strap and bonding wire should be connected directly between your wrist and an exposed metal part of the hardware. If you are using an anti-static mat, connect the wrist strap and bonding wire to the anti-static mat to ensure protection for any hardware placed on the mat.

The physical connection of the wrist strap and bonding wire between your skin, the anti-static mat, and the hardware is known as bonding. Use only Field Service kits with a wrist strap, anti-static mat, and bonding wire. Never use wireless wrist straps. Always be cautious that the internal wires of a wrist strap are prone to damage from normal wear and tear, and must be checked regularly with a wrist strap tester in order to avoid accidental ESD hardware damage. It is recommended to test the wrist strap and bonding wire at least once per week.

- **ESD Wrist Strap Tester** – The wires inside an ESD strap are prone to damage over time. When using an unmonitored ESD kit, it is recommended to test the wrist strap regularly—ideally before each service session, and at a minimum, once per week. The most reliable method for testing is with a wrist strap tester. To perform the test, connect the bonding wire of the wrist strap to the tester while wearing the strap. Press the test button to initiate the check. A green LED indicates a successful test, while a red LED and audible alarm signal a failure.

 **NOTE:** It is recommended to always use the traditional wired ESD grounding wrist strap and protective anti-static mat when servicing Dell products. In addition, it is critical to keep sensitive parts separate from all insulator parts while servicing the computer.

## Transporting sensitive components

When transporting ESD sensitive components such as replacement parts or parts to be returned to Dell, it is critical to place these parts in anti-static bags for safe transport.

## After working inside your computer

### About this task

 **CAUTION:** Leaving stray or loose screws inside your computer may severely damage your computer.

### Steps

1. Replace all screws and ensure that no stray screws remain inside your computer.
2. Connect any external devices, peripherals, or cables you removed before working on your computer.
3. Replace any media cards, disks, or any other parts that you removed before working on your computer.
4. Connect your computer to their electrical outlets.

 **NOTE:** To exit service mode, ensure to connect the AC adapter to the power-adapter port on your computer.

5. Press the power button to turn on the computer.

## BitLocker

 **CAUTION:** If BitLocker is not suspended before updating the BIOS, the next time you reboot the computer, it will not recognize the BitLocker key. You are prompted to enter the recovery key to progress, and the computer asks for this on each reboot. If the recovery key is not known this can result in data loss or an unnecessary operating system reinstall. For more information about this subject, *updating the BIOS on Dell computers with BitLocker enabled*, search in the Knowledge Base Resource at [Dell Support Site](#).

 **CAUTION:** If BitLocker is not suspended, replacing parts like system board or storage drives on a computer with BitLocker/Device encryption enabled triggers the encryption and locks the user out. The recovery key is required to regain access to Windows. The recovery key is automatically saved to the user's Microsoft Account (MSA) when the device is encrypted and can be retrieved from [Microsoft Account](#).

For more information about Windows Support, see article [Finding your BitLocker recovery key in Windows](#).

## BitLocker

When updating the BIOS on a computer with BitLocker enabled, consider the following precautions.

**CAUTION:** If BitLocker is not suspended before updating the BIOS, the BitLocker key will not be recognized the next time that you reboot the computer. You are prompted to enter the recovery key to progress, and the computer displays a prompt for the recovery key on each reboot. If the recovery key is not known, this can result in data loss or an operating system reinstall. For more information, see Knowledge Article: [updating the BIOS on Dell computers with BitLocker enabled](#).

The installation of the following components triggers BitLocker:

- Hard disk drive or solid state drive
- System board

## Recommended tools









The procedures in this document may require the following tools:

- Phillips screwdriver #0
- Plastic scribe







## Screw list

- NOTE:** When removing screws from a component, it is recommended to note the screw type and the quantity of screws, and then place them in a screw storage box. This is to ensure that the correct number of screws and correct screw type is restored when the component is replaced.
- NOTE:** Some computers have magnetic surfaces. Ensure that the screws are not left attached to such surfaces when replacing a component.
- NOTE:** Screw color may vary depending on the configuration ordered.

**Table 26. Screw list**

Component	Screw type	Quantity	Screw image
Base cover	M2x5	6	
	Captive screw <b>NOTE:</b> Screws are part of the base cover.	2	
Battery	M2x3	<ul style="list-style-type: none"> <li>• 3-cell battery: 3</li> <li>• 4-cell battery: 4</li> </ul>	
M.2 2230 solid state drive	M2x2	1	
Wireless-card bracket	M2x3.5	1	
Fan	M2x5	2	
Heat sink	Captive screw <b>NOTE:</b> Screws are part of the heat sink.	4	
Touchpad bracket	M2x2	3	

**Table 26. Screw list (continued)**

Component	Screw type	Quantity	Screw image
Touchpad	M2x2	2	
I/O daughter-board	M2x3	3	
Power button with optional fingerprint reader	M2x2	1	
Display assembly	M2.5x5	4	
Display hinges	M2.5x3.8	6	
System board	M2x2	1	
	M2x3.5	4	

## Major components of Dell Pro 15 Essential PV15250

The following image shows the major components of Dell Pro 15 Essential PV15250.



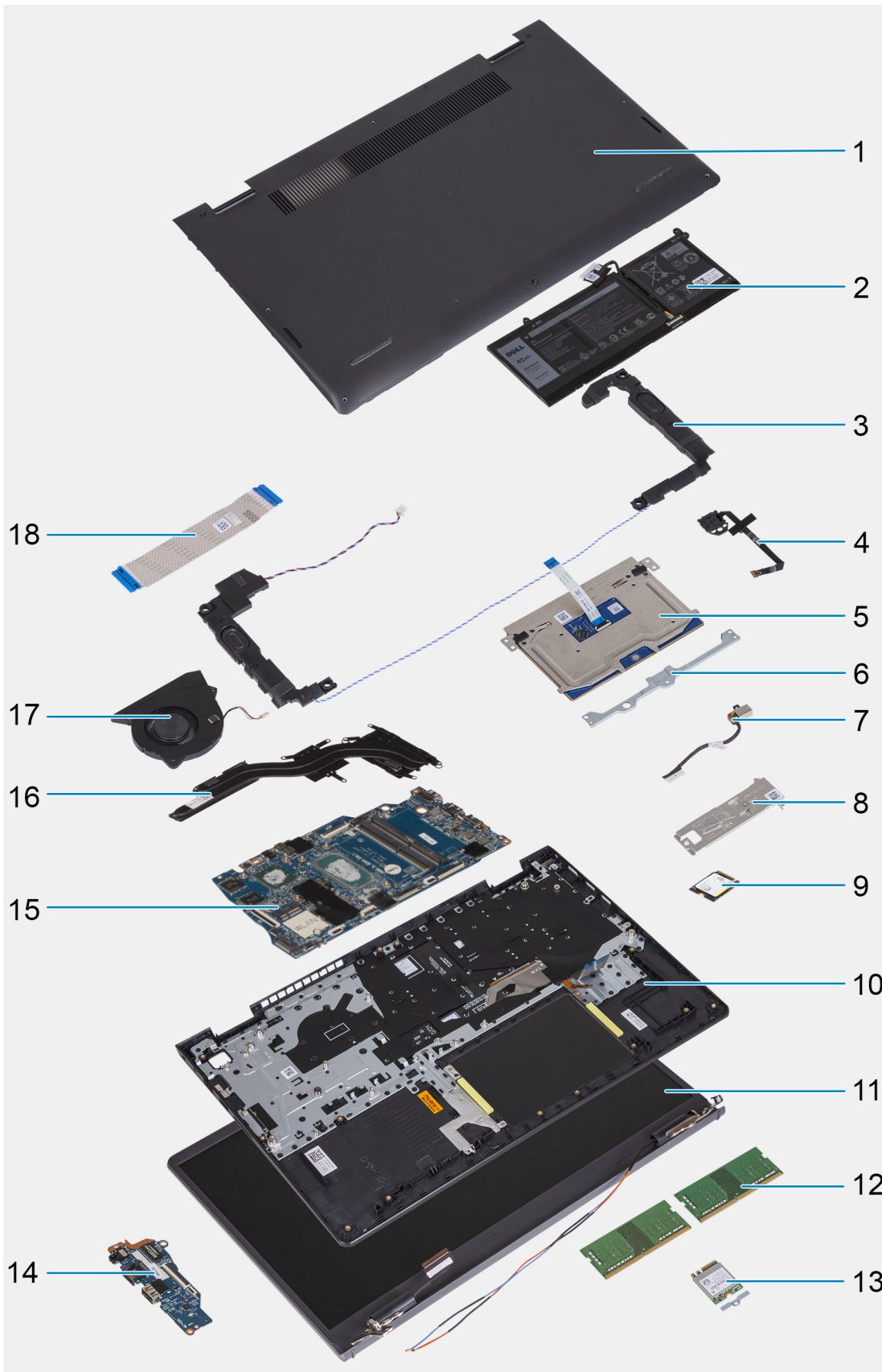

- |                       |  |
|-----------------------|--|
| 1. Base cover         | 2. Battery                                       |
| 3. Speakers           | 4. Power button with optional fingerprint reader |
| 5. Touchpad           | 6. Touchpad bracket                              |
| 7. Power-adaptor port | 8. Solid state drive bracket                     |

- 9. Solid state drive
- 10. Palm-rest and keyboard assembly
- 11. Display assembly
- 12. Memory module
- 13. Wireless card
- 14. I/O daughter-board
- 15. System board
- 16. Heat sink
- 17. Fan
- 18. I/O daughter-board cable

 **NOTE:** Dell provides a list of components and their part numbers for the original system configuration purchased. These parts are available according to warranty coverages purchased by the customer. Contact your Dell sales representative for purchase options.

# Removing and installing Customer Replaceable Units (CRUs)

The replaceable components in this chapter are Customer Replaceable Units (CRUs).

 **CAUTION:** Customers can replace only the Customer Replaceable Units (CRUs) following the safety precautions and replacement procedures.

 **NOTE:** The images in this document may differ from your computer depending on the configuration you ordered.

## Base cover

### Removing the base cover

#### Prerequisites

1. Follow the procedure in [Before working inside your computer](#).

 **NOTE:** Ensure that your computer is in Service Mode. For more information, see step 6 in [Before working inside your computer](#).

#### About this task

The following images indicate the location of the base cover and provide a visual representation of the removal procedure.



6x  
M2x5



2x

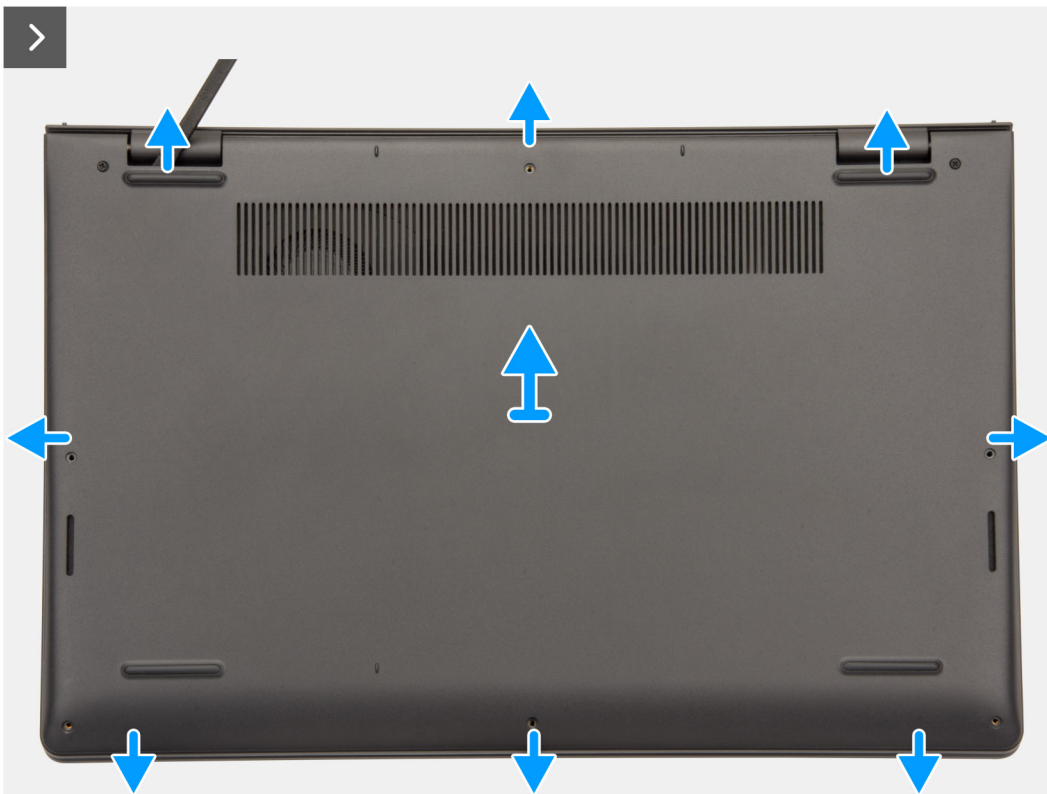



**6x**  
M2x5



**2x**





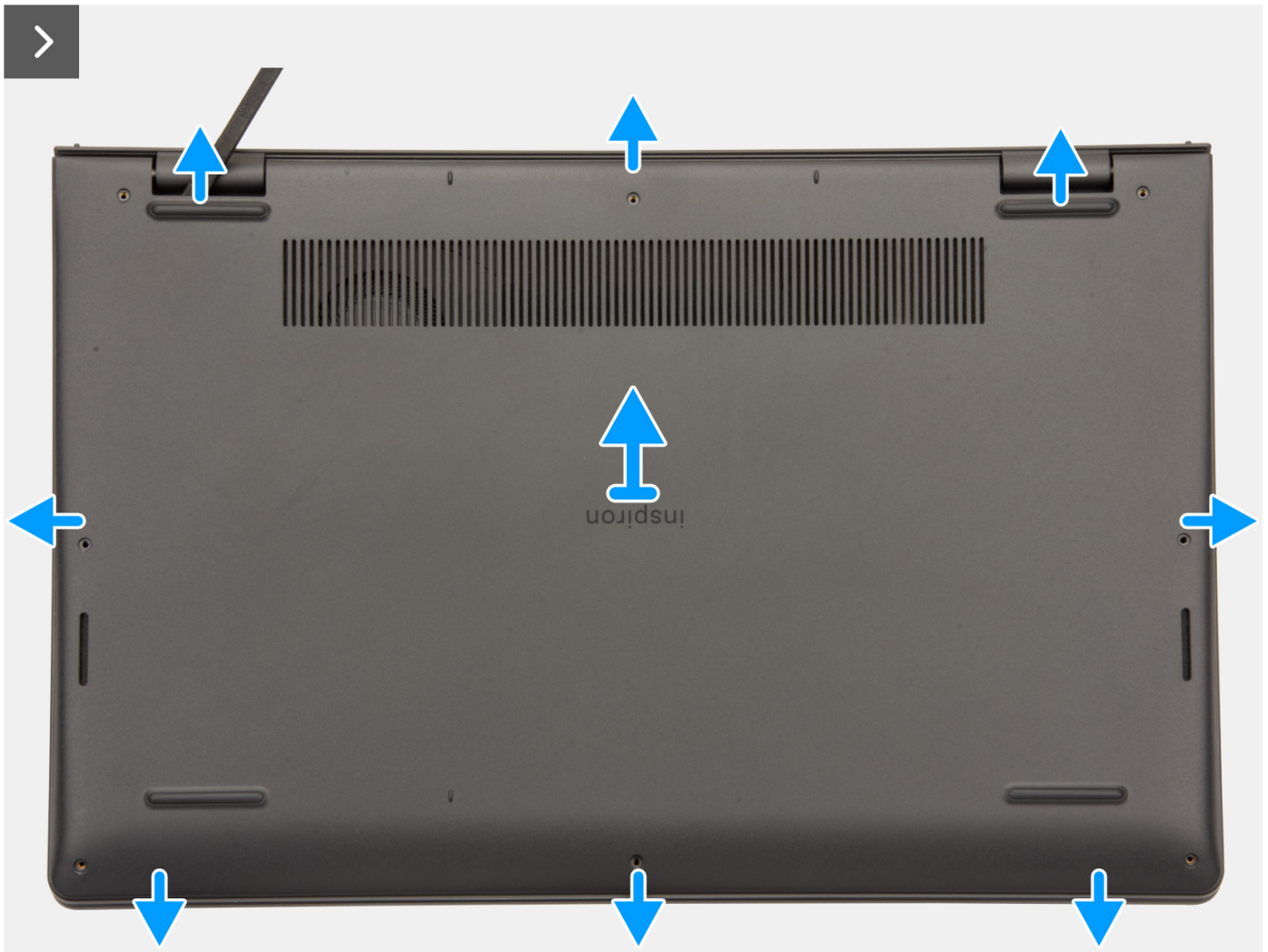

### Steps

1. Remove the six screws (M2x5) and loosen the two captive screws that secure the base cover to the palm-rest and keyboard assembly.
2. Using a plastic scribe, pry open the base cover starting from the recesses, which are located in the U-shaped indents at the top edge of the base cover, near the hinges.



3. Pry open the top side of the base cover and continue working on the left and right sides to open the base cover.
4. Lift and remove the base cover off the palm-rest and keyboard assembly.

## Installing the base cover

### Prerequisites

If you are replacing a component, remove the existing component before performing the installation procedure.

### About this task

The following images indicate the location of the base cover and provide a visual representation of the installation procedure.

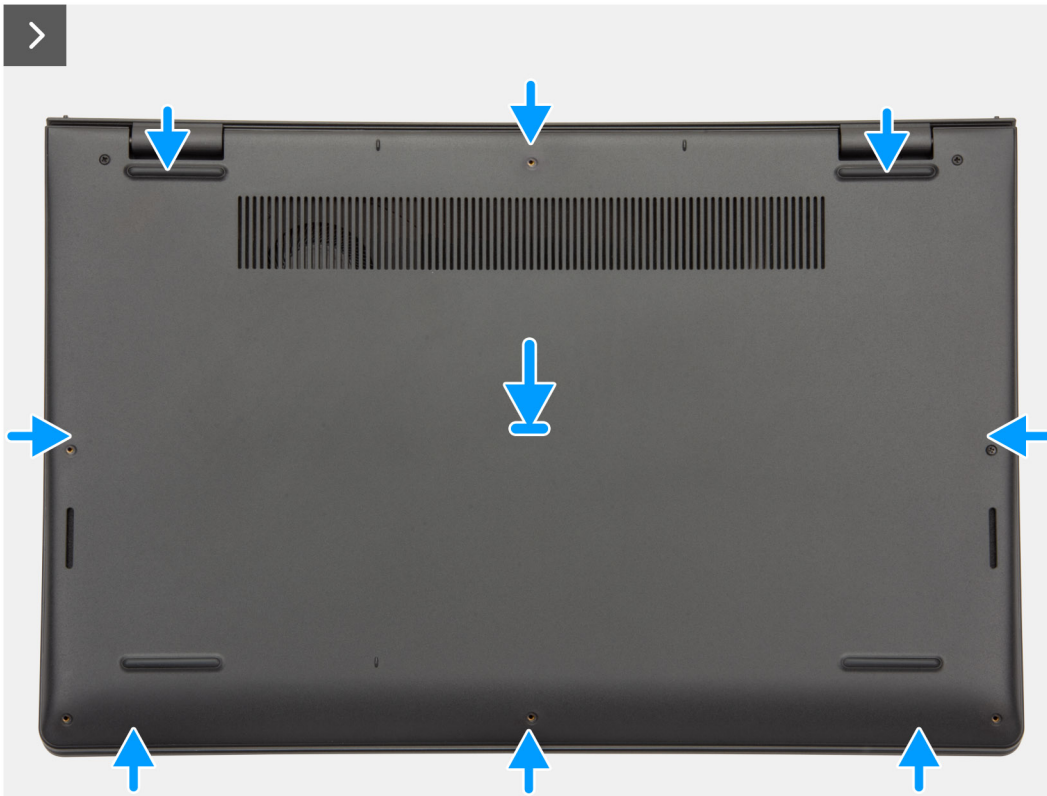



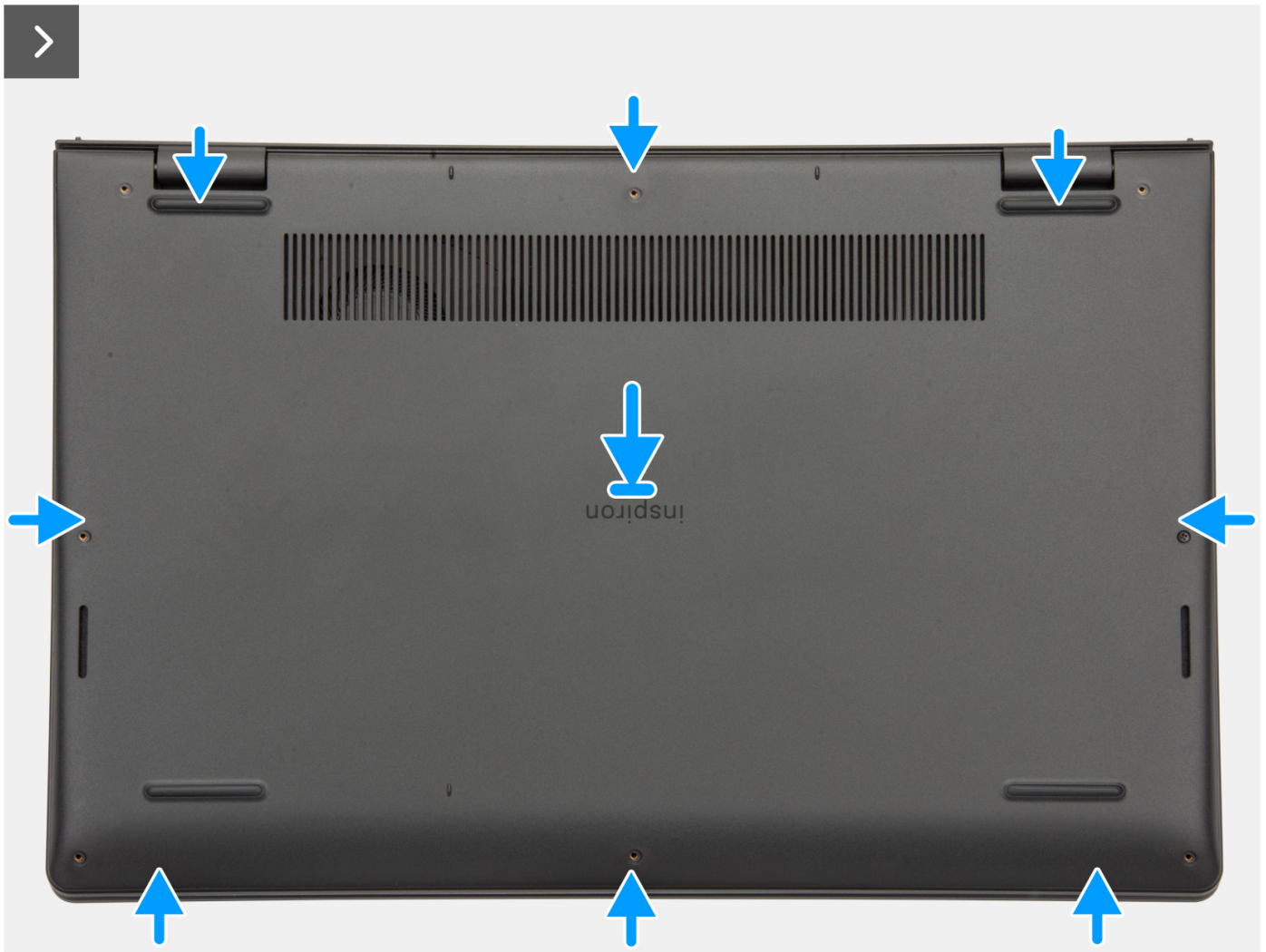



### Steps

1. Place the base cover on top of the palm-rest and keyboard assembly.
2. Align the screw holes on the base cover with the screw holes on the palm-rest and keyboard assembly, and snap the base cover latches into place.
3. Tighten the two captive screws and replace the six screws (M2x5) to secure the base cover to the palm-rest and keyboard assembly.

### Next steps

1. Follow the procedure in [After working inside your computer](#).

## Memory module

### Removing the memory module

#### Prerequisites

1. Follow the procedure in [Before working inside your computer](#).
2. Remove the [base cover](#).

#### About this task

The following images indicate the location of the memory module and provide a visual representation of the removal procedure.

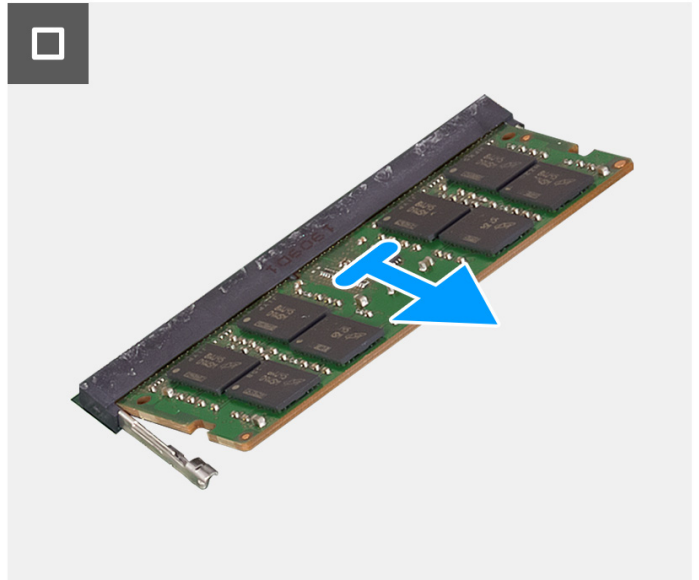
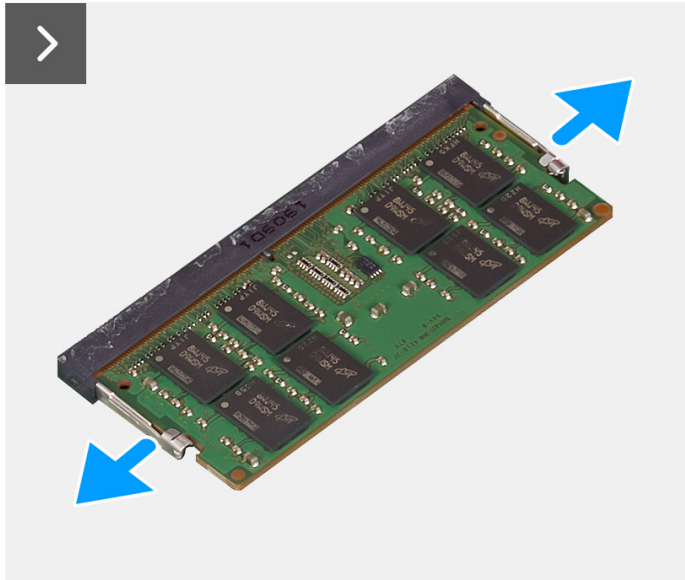
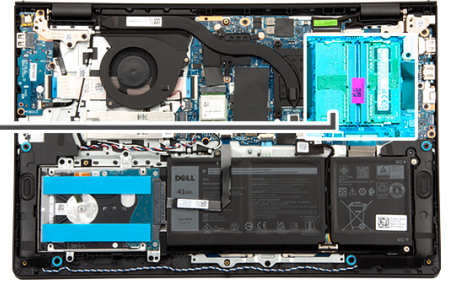
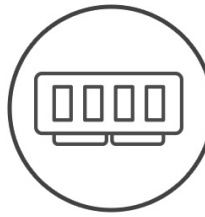

### Steps

1. Using a plastic scribe, carefully pry the memory-module retention clips away from the memory module until the memory module pops-up.
2. Slide the memory module at an angle and remove it from the memory-module slot on the system board.
3. Repeat step 1 and 2 for the second memory module, if installed.

## Installing the memory module

### Prerequisites

If you are replacing a component, remove the existing component before performing the installation procedure.

### About this task

The following images indicate the location of the memory module and provide a visual representation of the installation procedure.

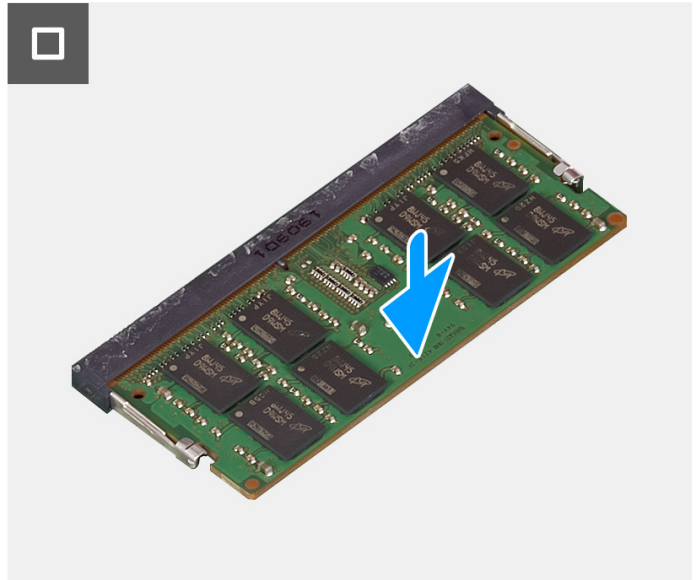
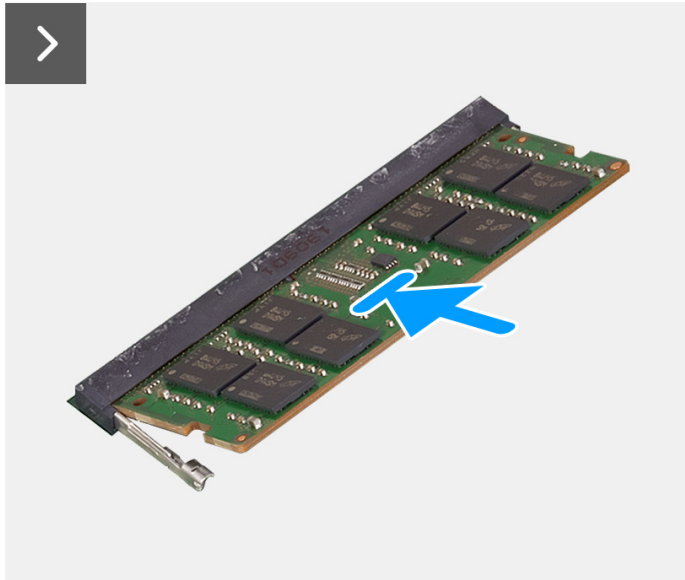
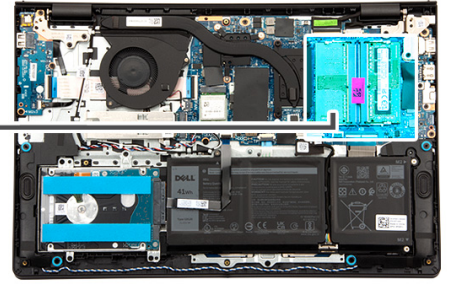
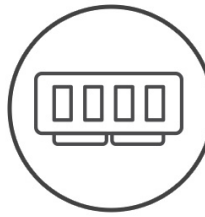

### Steps

1. Align the notch on the memory module with the tab on the memory-module slot on the system board.
2. Slide the memory module firmly into the memory-module slot at an angle.
3. Press down on the memory module to snap it on the system board. Ensure that the memory-module retention clips have locked the memory module.

**i** **NOTE:** If you do not hear the click, remove the memory module and reinstall it.

4. Repeat steps 1, 2 and 3 to install the second memory module, if applicable.

### Next steps

1. Install the [base cover](#).
2. Follow the procedure in [After working inside your computer](#).

## Solid state drive

### Removing the solid state drive

#### Prerequisites

1. Follow the procedure in [Before working inside your computer](#).
2. Remove the [base cover](#).

### About this task

The following images indicate the location of the solid state drive and provide a visual representation of the removal procedure.

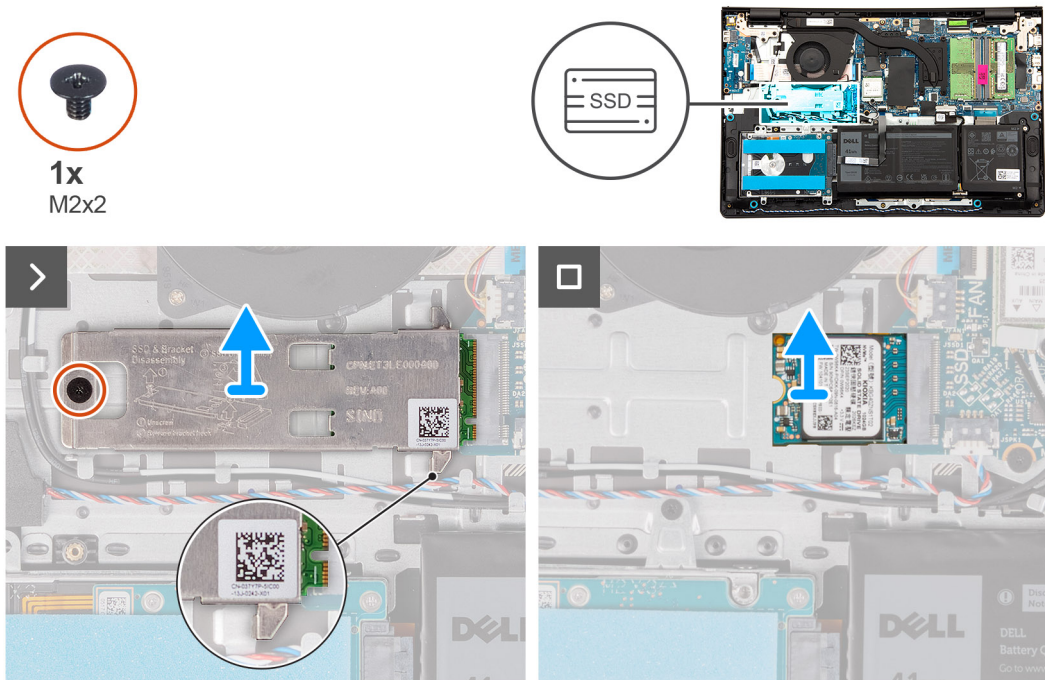

Figure 2. Removing the solid state drive

### Steps

1. Remove the screw (M2x2) that secures the solid state drive thermal plate to the palm-rest and keyboard assembly.
2. Slide and remove the solid state drive thermal plate from the solid state drive.
3. Slide and remove the solid state drive from the M.2 card slot on the system board.

## Installing the solid state drive

### Prerequisites

If you are replacing a component, remove the existing component before performing the installation procedure.

### About this task

The following images indicate the location of the solid state drive and provide a visual representation of the installation procedure.



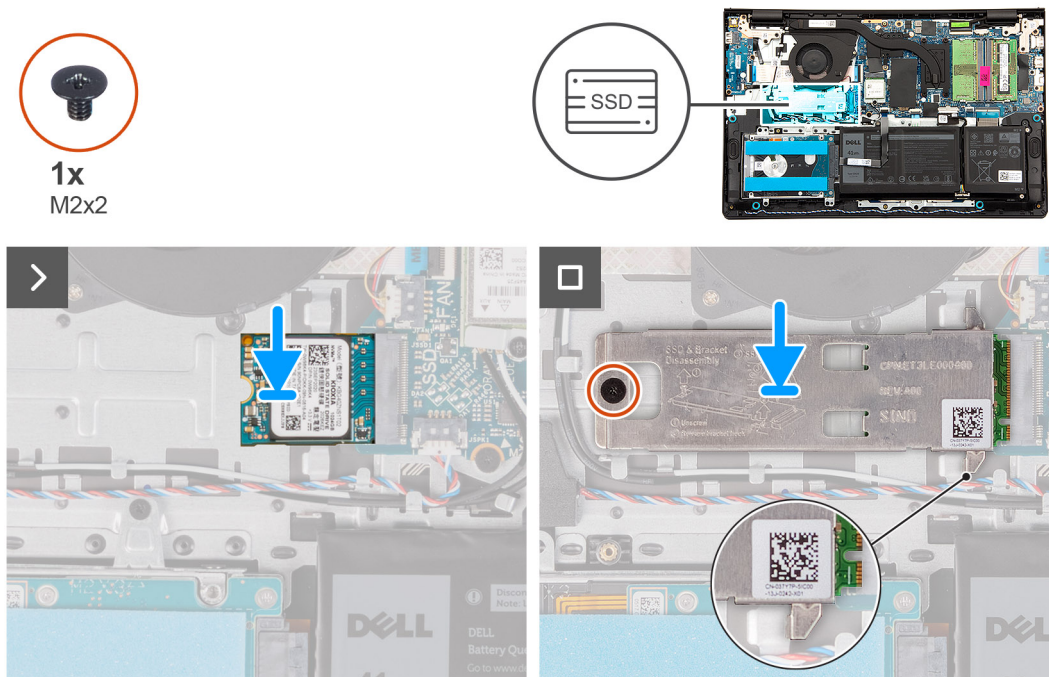

**Figure 3. Installing the solid state drive**

### Steps

1. Align the notch on the solid state drive with the tab on the M.2 card slot on the system board.
2. Slide the solid state drive in the M.2 card slot on the system board.
3. Place the solid state drive thermal plate on the solid state drive.
  - NOTE:** When installing the solid state drive thermal plate on the system, tuck the tabs on the solid state drive thermal plate under the hooks on the palm-rest and keyboard assembly.
4. Align the screw hole on the solid state drive thermal plate with the screw hole on the palm-rest and keyboard assembly.
5. Replace the screw (M2x2) to secure the solid state drive thermal plate to the palm-rest and keyboard assembly.

### Next steps

1. Install the [base cover](#).
2. Follow the procedure in [After working inside your computer](#).

## Wireless card

### Removing the wireless card

#### Prerequisites

1. Follow the procedure in [Before working inside your computer](#).
2. Remove the [base cover](#).

#### About this task

The following images indicate the location of the wireless card and provide a visual representation of the removal procedure.



1x  
M2x3.5

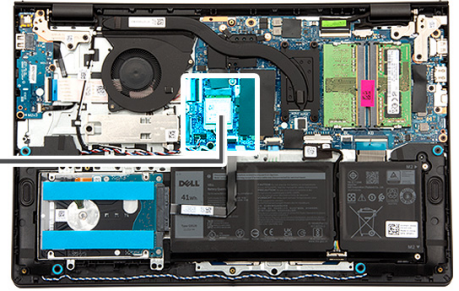

### Steps

1. Remove the screw (M2x3.5) that secures the wireless-card bracket to the system board.
2. Lift the wireless-card bracket off the wireless card.
3. Disconnect the wireless-antenna cables from the connectors on the wireless card.
4. Slide and remove the wireless card from the wireless-card slot on the system board.

## Installing the wireless card

### Prerequisites

If you are replacing a component, remove the existing component before performing the installation procedure.

**About this task**

The following images indicate the location of the wireless card and provide a visual representation of the installation procedure.



**1x**  
M2x3.5

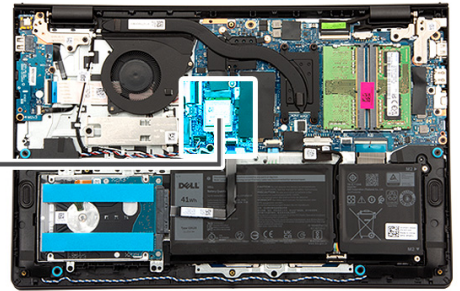

**Steps**

1. At an angle, slide the wireless card into the wireless-card slot on the system board.
2. Connect the wireless-antenna cables to the wireless card.

The following table provides the antenna-cable color scheme for the wireless card supported by your computer.

**Table 27. Antenna-cable color scheme**

Connector on the wireless card	Antenna-cable color	Silkscreen marking	
Main	White	MAIN	△ (white triangle)



**Table 27. Antenna-cable color scheme**

Connector on the wireless card	Antenna-cable color	Silkscreen marking
Auxiliary	Black	AUX ▲ (black triangle)

3. Place the wireless-card bracket on the wireless card.
4. Align the screw hole on the wireless-card bracket with the screw hole on the system board.
5. Replace the screw (M2x3.5) to secure the wireless-card bracket and the wireless card to the system board.

**Next steps**

1. Install the [base cover](#).
2. Follow the procedure in [After working inside your computer](#).

# Speakers

## Removing the speakers

**Prerequisites**

1. Follow the procedure in [Before working inside your computer](#).
2. Remove the [base cover](#).

**About this task**

The following image indicates the location of the speakers and provides a visual representation of the removal procedure.

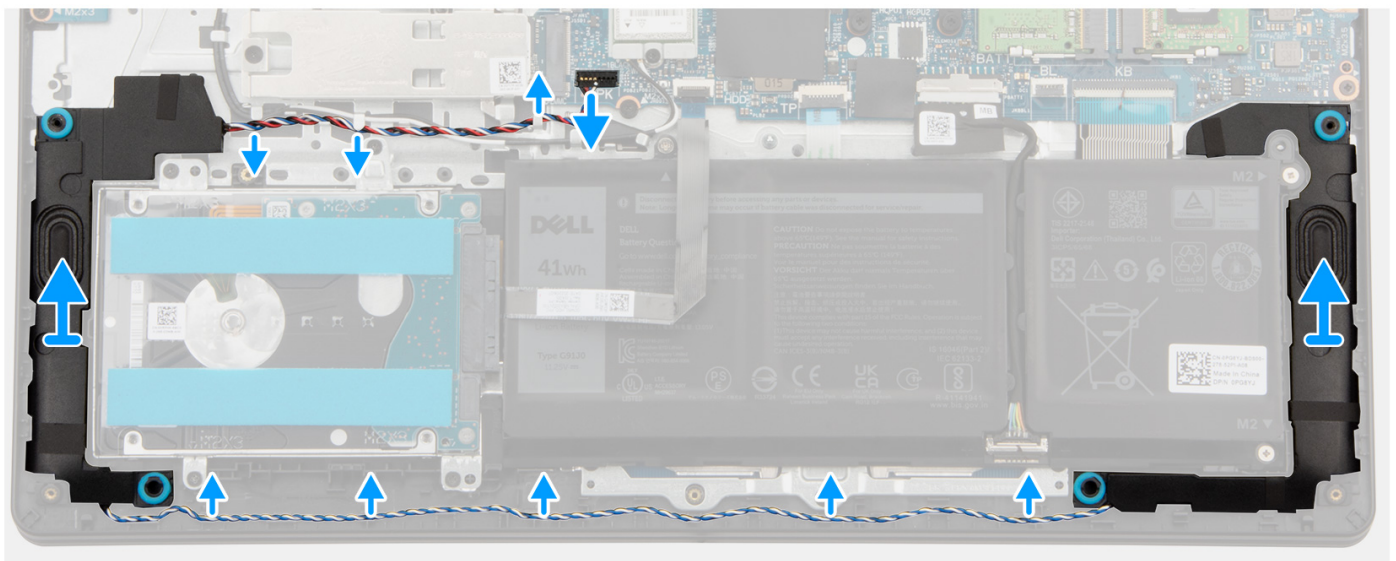
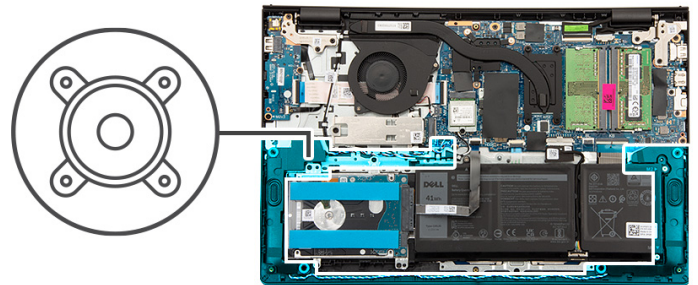

## Steps

1. Disconnect the speaker cable from the connector on the system board.

**NOTE:** To disconnect the speaker cable featuring an eight-pin connector from the system board, pry up the bottom side of the cable connector's head first and then pull it away from the connector.

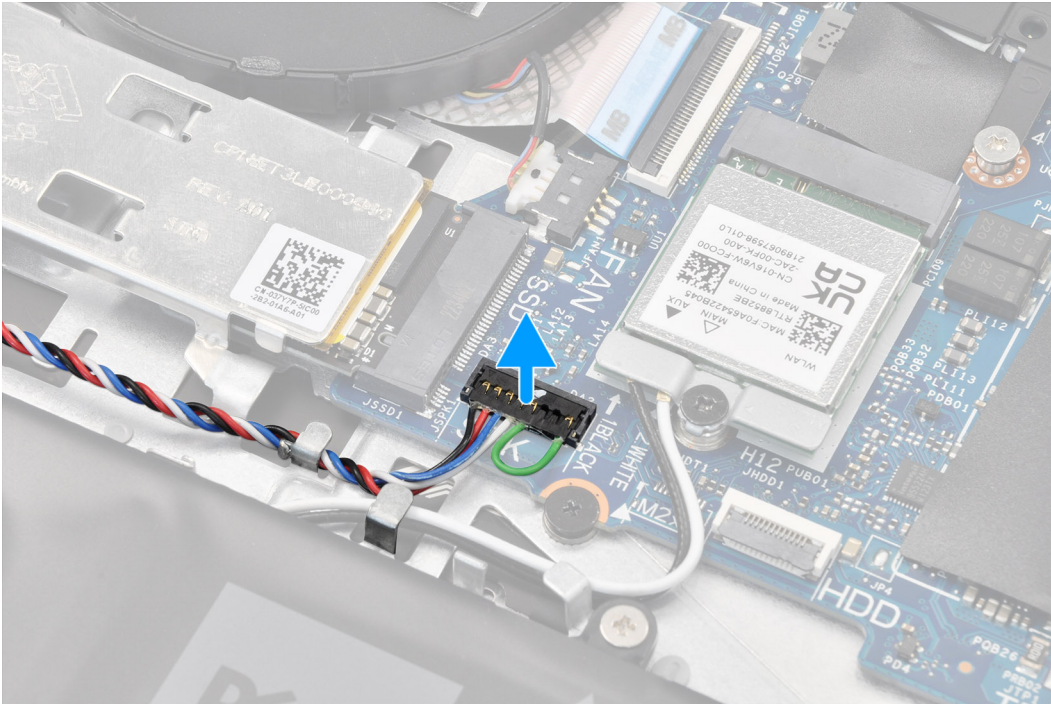

2. Unroute and remove the speaker cable from the routing guides on palm-rest and keyboard assembly.
3. Lift the speakers, along with the cable, off the palm-rest and keyboard assembly.

## Installing the speakers

### Prerequisites

If you are replacing a component, remove the existing component before performing the installation procedure.

### About this task

**NOTE:** If the rubber grommets are pushed out when removing the speakers, push them back in before replacing the speakers.

The following image indicates the location of the speakers and provides a visual representation of the installation procedure.

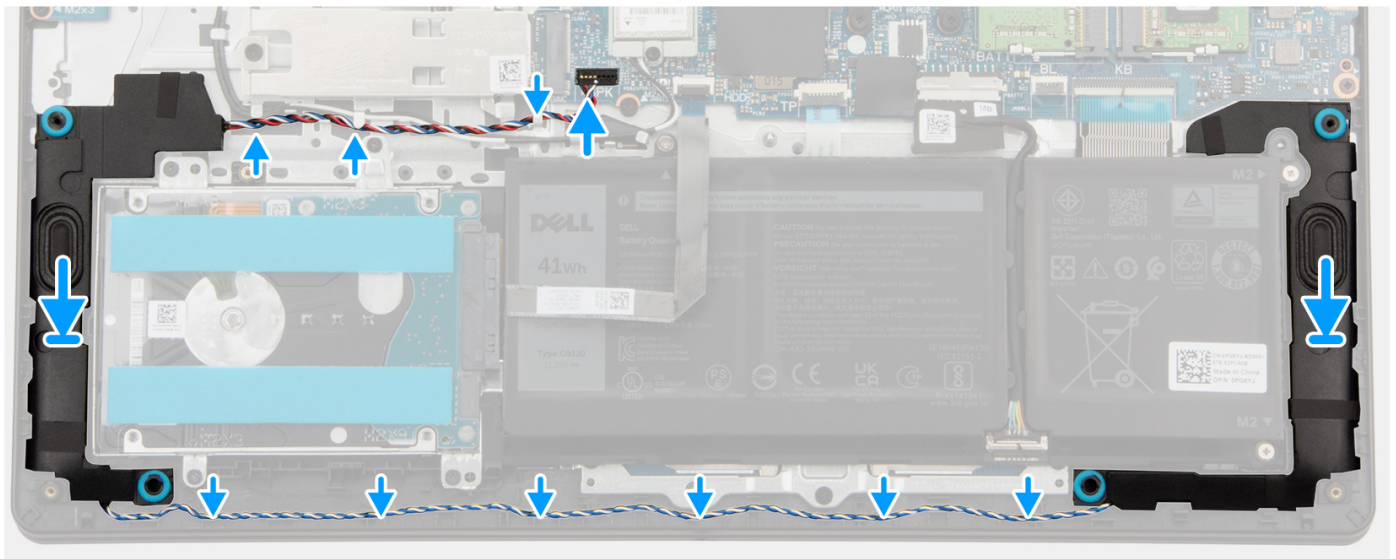
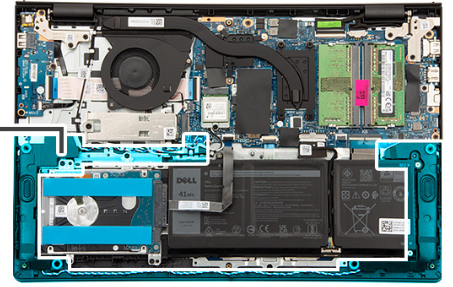
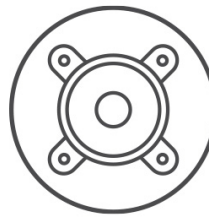

### Steps

1. Using the alignment posts and rubber grommets, place the speakers in the slots on the palm-rest and keyboard assembly.  
**(i) NOTE:** Ensure that the alignment posts are threaded through the rubber grommets on the speakers.
2. Route the speaker cable along the bottom side of the palm-rest and keyboard assembly, over the wireless-antenna cables. Then secure the speaker cable into the routing guides on the palm-rest and keyboard assembly.  
**(i) NOTE:** The speaker cable must be routed through the routing guides to avoid damaging the speaker cable when installing the base cover.

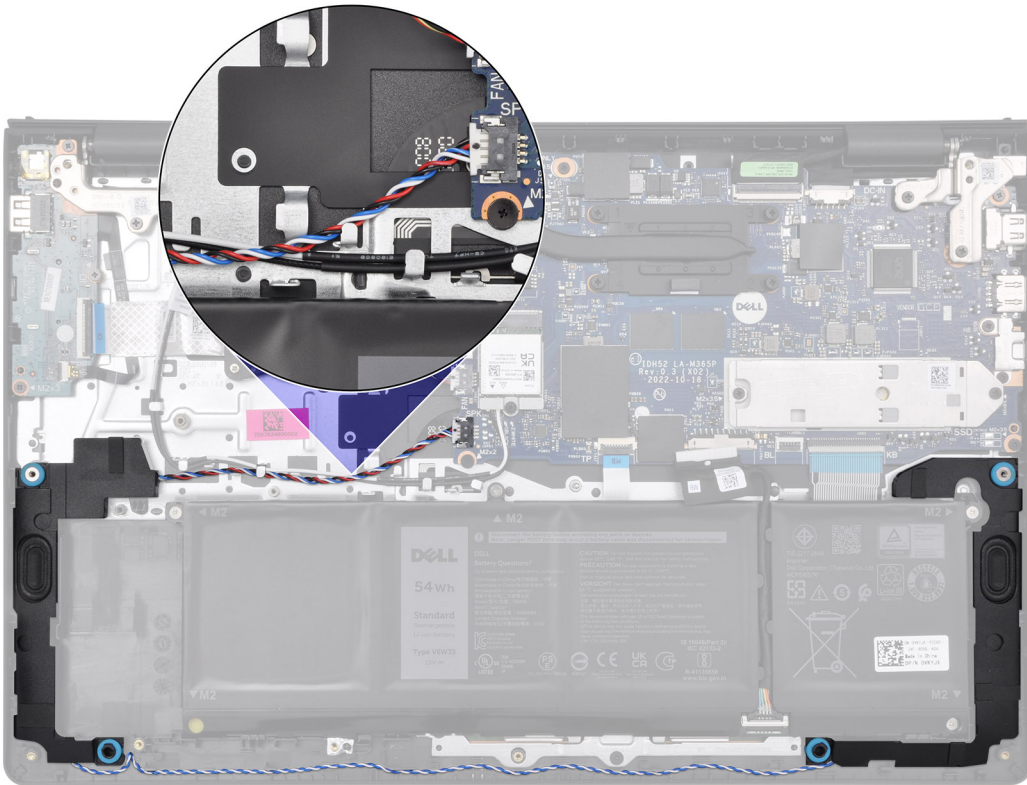

3. Connect the speaker cable to the connector on the system board.

#### Next steps

1. Install the [base cover](#).
2. Follow the procedure in [After working inside your computer](#).

## Fan

### Removing the fan

#### Prerequisites

1. Follow the procedure in [Before working inside your computer](#).
2. Remove the [base cover](#).

#### About this task

The following image indicates the location of the fan and provides a visual representation of the removal procedure.





2x  
M2x5

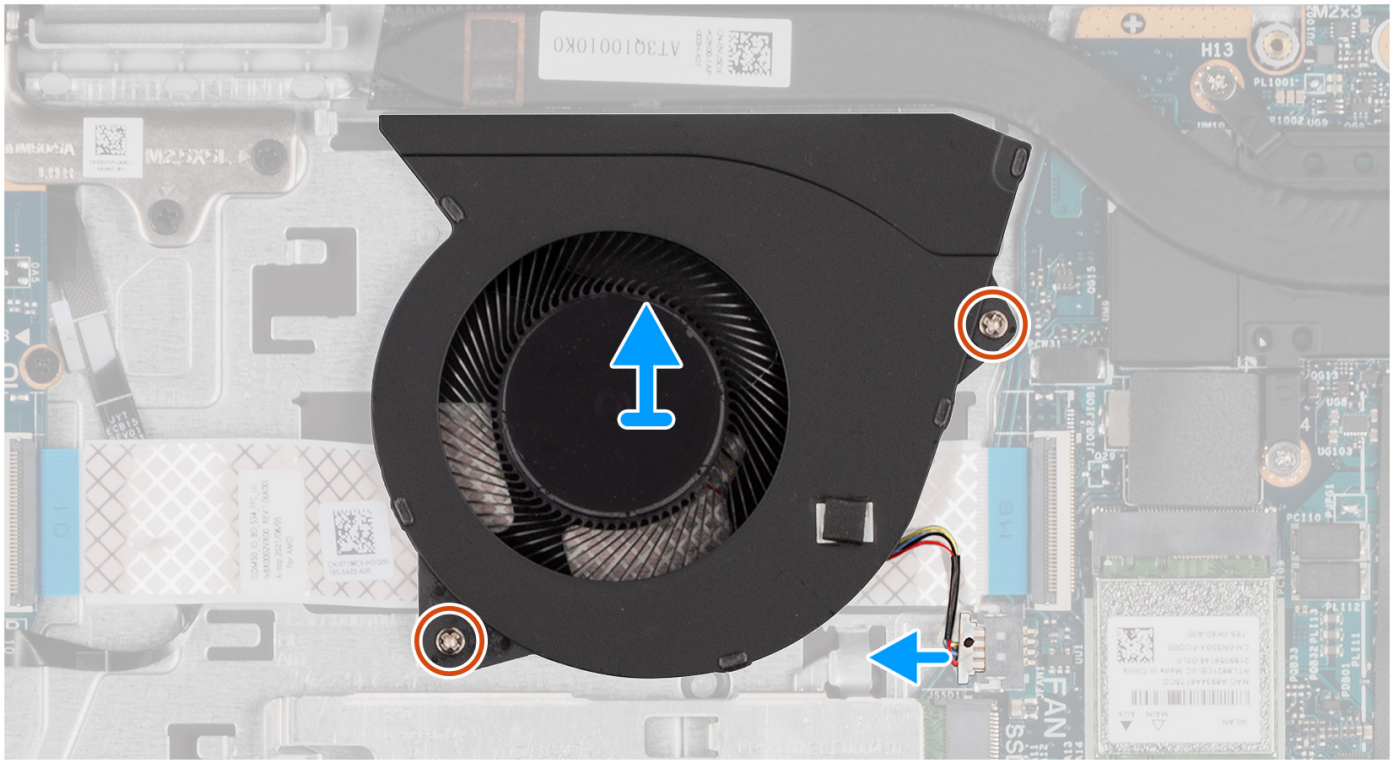
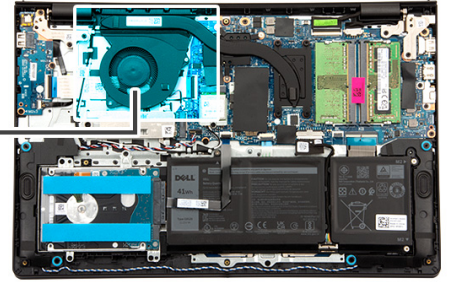
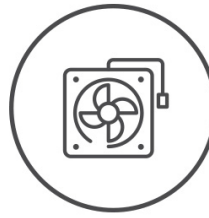

### Steps

1. Disconnect the fan cable from the connector on the system board.
2. Remove the two screws (M2x5) that secure the fan to the palm-rest and keyboard assembly.
3. Lift the fan off the palm-rest and keyboard assembly.

## Installing the fan

### Prerequisites

If you are replacing a component, remove the existing component before performing the installation procedure.

### About this task

The following image indicates the location of the fan and provides a visual representation of the installation procedure.



**2x**  
M2x5

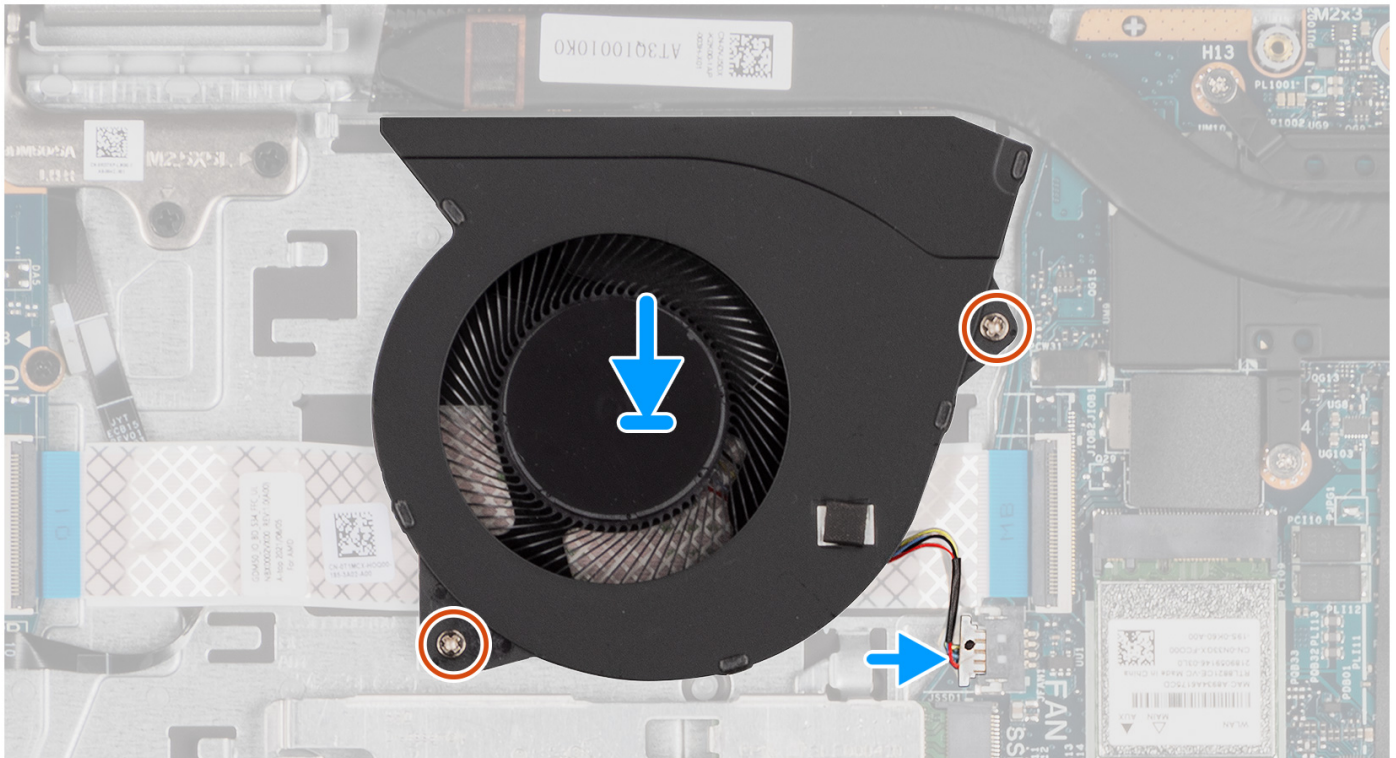
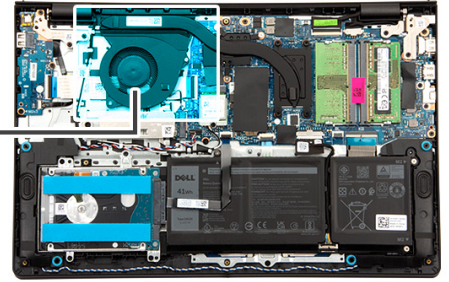
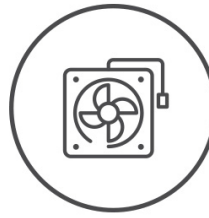

### Steps

1. Place the fan in the slot on the palm-rest and keyboard assembly.
2. Align the screw holes on the fan to the screw holes on the palm-rest and keyboard assembly.
3. Replace the two screws (M2x5) to secure the fan to the palm-rest and keyboard assembly.
4. Connect the fan cable to the connector on the system board.

### Next steps

1. Install the [base cover](#).
2. Follow the procedure in [After working inside your computer](#).

# Removing and installing Field Replaceable Units (FRUs)

The replaceable components in this chapter are Field Replaceable Units (FRUs).

**CAUTION:** The information in this section is intended for authorized service technicians only.

**CAUTION:** To avoid any potential damage to the component or loss of data, ensure that an authorized service technician replaces the Field Replaceable Units (FRUs).

**CAUTION:** Dell Technologies recommends that these procedures be performed by trained technical repair specialists.

**CAUTION:** Your warranty does not cover damages that may occur during FRU repairs that are not authorized by Dell Technologies.

**NOTE:** The images in this document may differ from your computer depending on the configuration you ordered.

## Battery

### Rechargeable Li-ion battery precautions

**WARNING:**

- Exercise caution when handling rechargeable Li-ion batteries.
- Discharge the battery completely before removing it. Disconnect the AC power adapter from the computer and operate the computer solely on battery power—the battery is fully discharged when the computer no longer turns on when the power button is pressed.
- Do not crush, drop, mutilate, or penetrate the battery with foreign objects.
- Do not expose the battery to high temperatures, or disassemble battery packs and cells.
- Do not apply pressure to the surface of the battery.
- Do not bend the battery.
- Do not use tools of any kind to pry on or against the battery.
- To prevent accidental puncture or damage to the battery and other components, ensure that no screws are lost or misplaced during the servicing of the computer.
- Always purchase genuine batteries from [Dell Site](#) or authorized Dell partners and resellers.
- Swollen batteries should not be used and should be replaced and disposed properly. For guidelines on how to handle and replace swollen rechargeable Li-ion batteries, see [Handling swollen rechargeable Li-ion batteries](#).

### Removing the 3-cell battery

**CAUTION:** The information in this section is intended for authorized service technicians only.

#### Prerequisites

1. Follow the procedure in [Before working inside your computer](#).
2. Remove the [base cover](#).



## About this task

The following images indicate the location of the 3-cell battery and provide a visual representation of the removal procedure.



3x  
M2x3

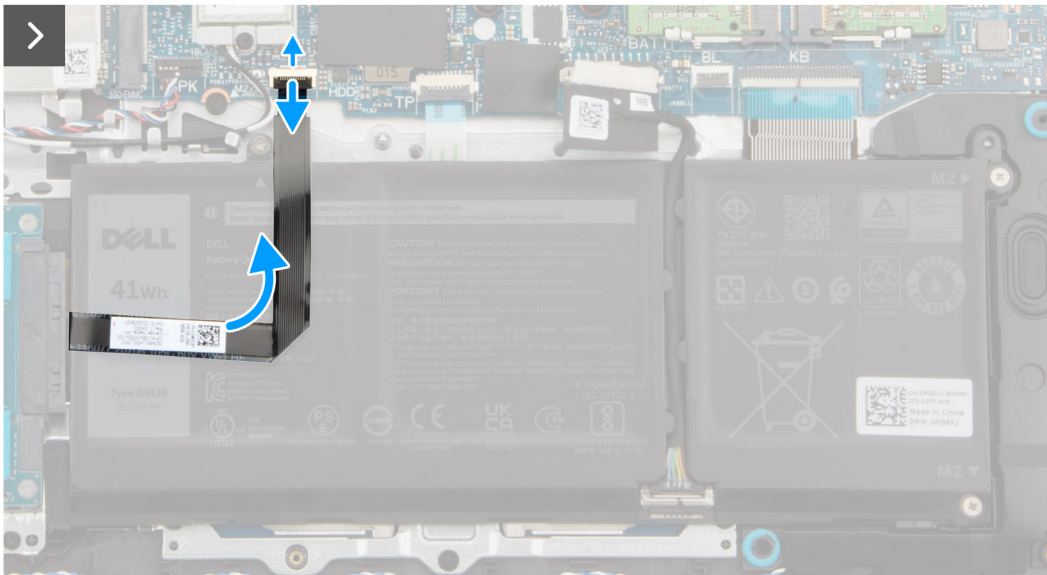
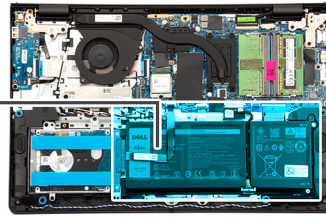
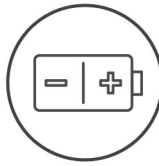

## Steps

1. Disconnect the hard-drive flexible flat cable from the connector on the system board.  
**NOTE:** Disconnect the hard-drive flexible flat cable to avoid tugging of the hard-drive flexible flat cable on the 3-cell battery.
2. Using the pull tab, disconnect the battery cable from the connector on the system board.
3. Remove the three screws (M2x3) that secure the 3-cell battery to the palm-rest and keyboard assembly.
4. Lift the 3-cell battery, along with the battery cable, off the palm-rest and keyboard assembly.



**NOTE:** Computers shipped with an aluminum chassis have two RF metal wall brackets installed on the left and right sides of the palm-rest and keyboard assembly. The right bracket is secured by the battery with no screw, tape, or adhesives otherwise securing the bracket in place. Technicians should take note of whether the bracket has fallen out of the computer during subsequent removal procedures.

## Installing the 3-cell battery

**CAUTION:** The information in this section is intended for authorized service technicians only.

### Prerequisites

If you are replacing a component, remove the existing component before performing the installation procedure.

### About this task

The following images indicate the location of the 3-cell battery and provide a visual representation of the installation procedure.



3x  
M2x3

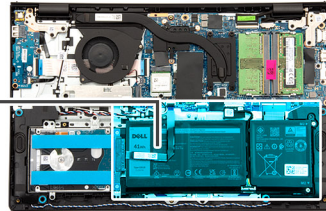
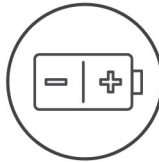

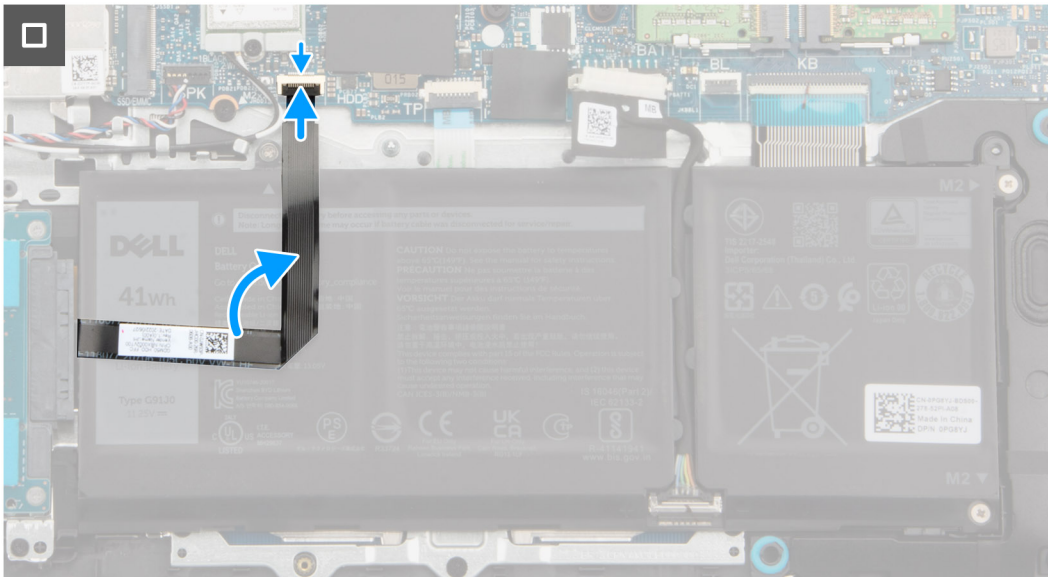

### Steps

1. Place the 3-cell battery, along with the battery cable, in the slot on the palm-rest and keyboard assembly.
2. Align the screw holes on the 3-cell battery to the screw holes on the palm-rest and keyboard assembly.
3. Replace the three screws (M2x3) to secure the 3-cell battery to the palm-rest and keyboard assembly.
4. Connect the battery cable to the connector on the system board.
5. Connect the hard-drive flexible flat cable to the connector on the system board.

### Next steps

1. Install the [base cover](#).
2. Follow the procedure in [After working inside your computer](#).

## Removing the 4-cell battery

**CAUTION:** The information in this section is intended for authorized service technicians only.

### Prerequisites

1. Follow the procedure in [Before working inside your computer](#).
2. Remove the [base cover](#).

### About this task

The following image indicates the location of the 4-cell battery and provides a visual representation of the removal procedure.

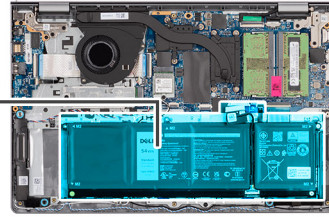
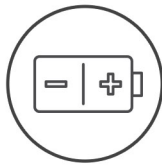

## Steps

1. Using the pull tab, disconnect the battery cable from the connector on the system board.
2. Remove the four screws (M2x3) that secure the 4-cell battery to the palm-rest and keyboard assembly.
3. Lift the 4-cell battery, along with the battery cable, off the palm-rest and keyboard assembly.
  - NOTE:** Computers shipped with an aluminum chassis have two RF metal wall brackets installed on the left and right sides of the palm-rest and keyboard assembly. The right bracket is secured by the battery with no screw, tape, or adhesives otherwise securing the bracket in place. As a result, technicians should take note of whether the bracket has fallen out of the computer during subsequent removal procedures.
4. Carefully push and remove the battery rubber stopper out of the bottom-left screw hole of the 4-cell battery.
  - NOTE:** When replacing the 4-cell battery, use a plastic scribe to push upward through the bottom-left screw hole to remove the battery rubber stopper and transfer it to the new replacement 4-cell battery.

## Installing the 4-cell battery

**CAUTION:** The information in this section is intended for authorized service technicians only.

### Prerequisites

If you are replacing a component, remove the existing component before performing the installation procedure.

### About this task

The following image indicates the location of the 4-cell battery and provides a visual representation of the installation procedure.

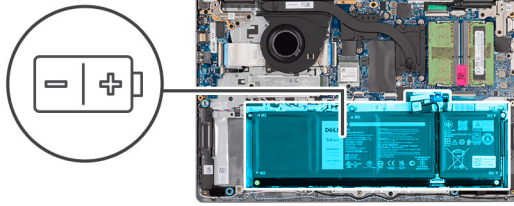

## Steps

1. Carefully push and insert the battery rubber stopper into the bottom-left screw hole of the 4-cell battery.  
**i** **NOTE:** When replacing the 4-cell battery, use a plastic scribe to push downward into the bottom-left screw hole to insert the battery rubber stopper into the slot on the new replacement 4-cell battery.
2. Place the 4-cell battery, along with the battery cable, in the slot on the palm-rest and keyboard assembly.
3. Align the screw holes on the 4-cell battery to the screw holes on the palm-rest and keyboard assembly.
4. Replace the four screws (M2x3) to secure the 4-cell battery to the palm-rest and keyboard assembly.
5. Connect the battery cable to the connector on the system board.

## Next steps

1. Install the [base cover](#).
2. Follow the procedure in [After working inside your computer](#).

## Disconnecting the battery cable

**⚠ CAUTION:** The information in this section is intended for authorized service technicians only.

### Prerequisites

1. Follow the procedure in [Before working inside your computer](#).
2. Remove the [base cover](#).
3. Remove the [3-cell battery](#) or the [4-cell battery](#), whichever applicable.

### About this task

The following image indicates the location of the battery cable and provides a visual representation of the removal procedure.



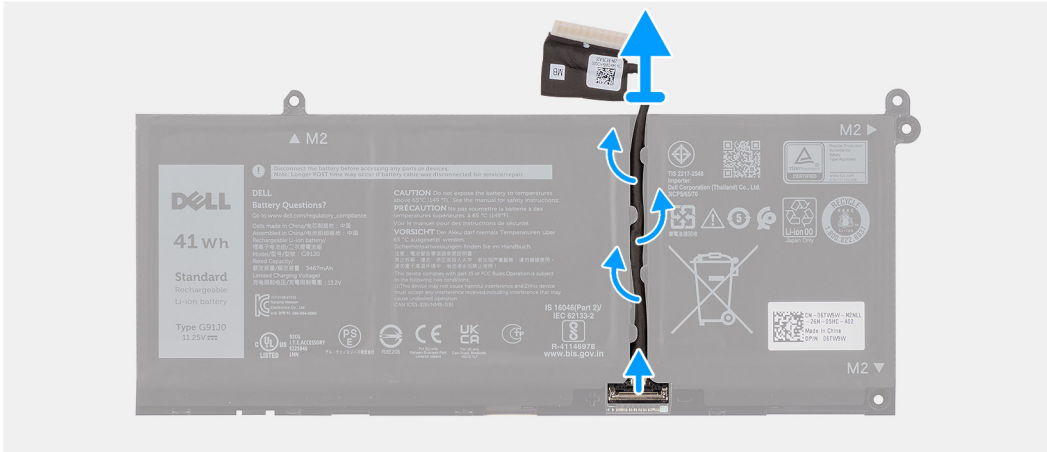

### Steps

1. Unroute the battery cable from the routing guides on the battery.
2. Open the latch and disconnect the battery cable from the connector on the battery.

**i** **NOTE:** To disconnect the battery cable, first push the latch downward to release the connector, and then pull the connector upward to disconnect it from the battery.

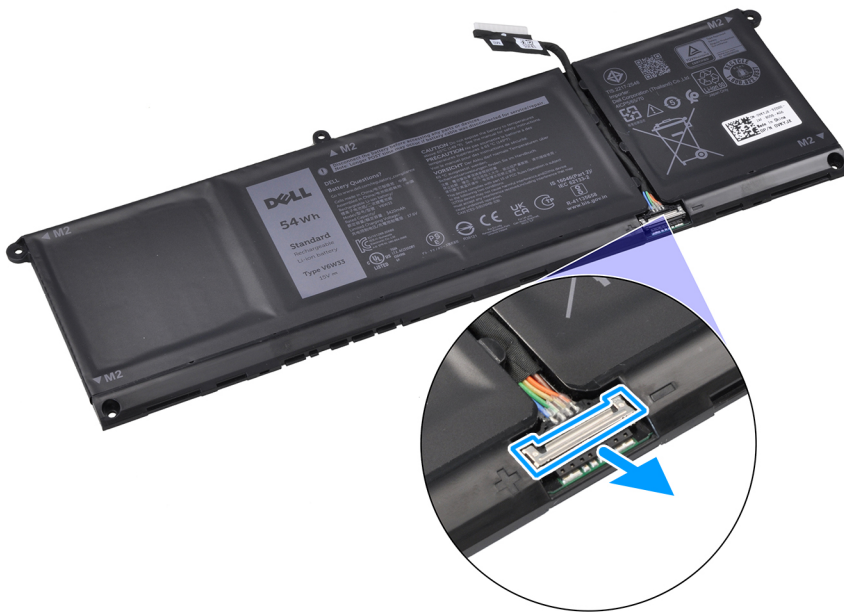

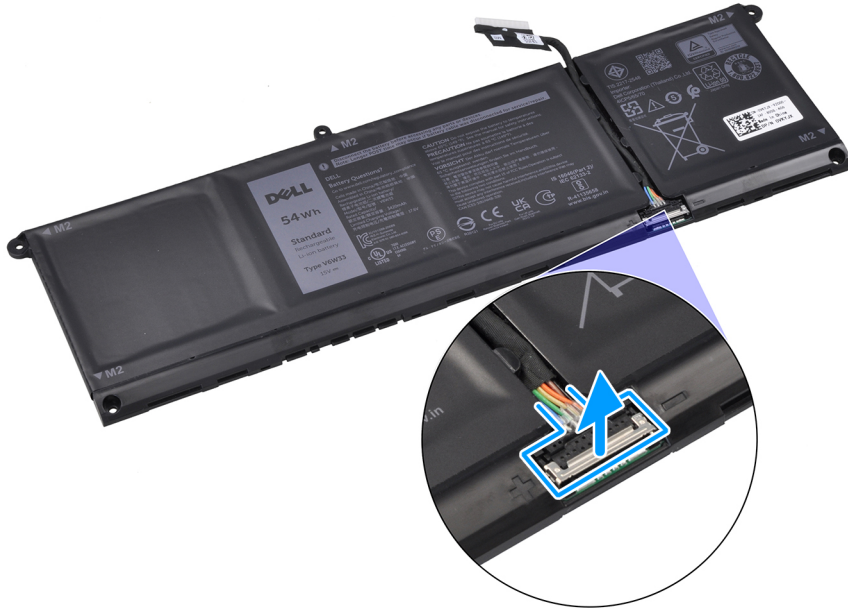

**CAUTION:** DO NOT pull the battery cable to disconnect it from the battery. This may damage the battery or the battery cable.

## Connecting the battery cable

**CAUTION:** The information in this section is intended for authorized service technicians only.

### Prerequisites

If you are replacing a component, remove the existing component before performing the installation procedure.

### About this task

The following image indicates the location of the battery cable and provides a visual representation of the installation procedure.

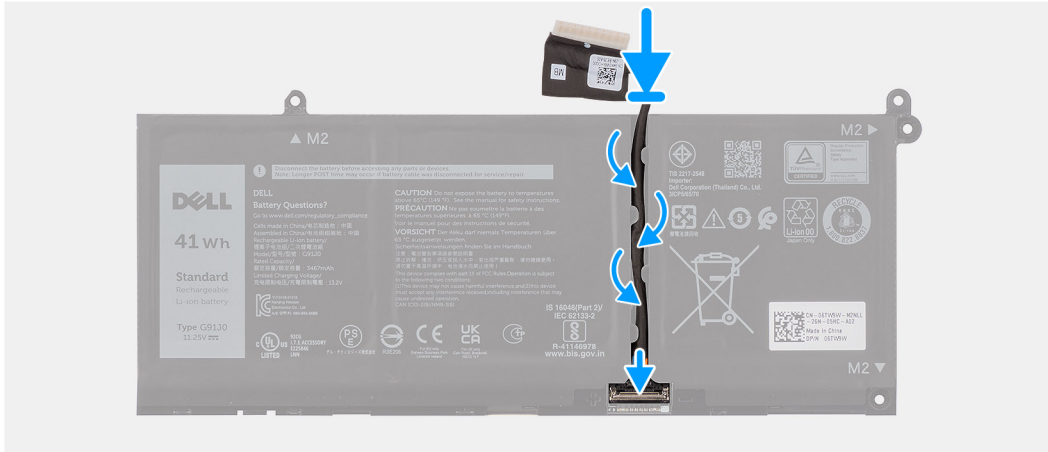

### Steps

1. Connect the battery cable to the connector on the battery and close the latch.
2. Route the battery cable through the routing guides on the battery.

### Next steps

1. Install the [3-cell battery](#) or the [4-cell battery](#), whichever applicable.
2. Install the [base cover](#).
3. Follow the procedure in [After working inside your computer](#).

## Heat sink

### Removing the heat sink

**CAUTION:** The information in this section is intended for authorized service technicians only.

#### Prerequisites

1. Follow the procedure in [Before working inside your computer](#).
2. Remove the [base cover](#).

#### About this task

- NOTE:** The heat sink may become hot during normal operation. Allow sufficient time for the heat sink to cool before you touch it.
- NOTE:** For maximum cooling of the processor, do not touch the heat-transfer areas on the heat sink. The oils in your skin can reduce the heat-transfer capability of the thermal grease.

The following image indicates the location of the heat sink and provides a visual representation of the removal procedure.



4x

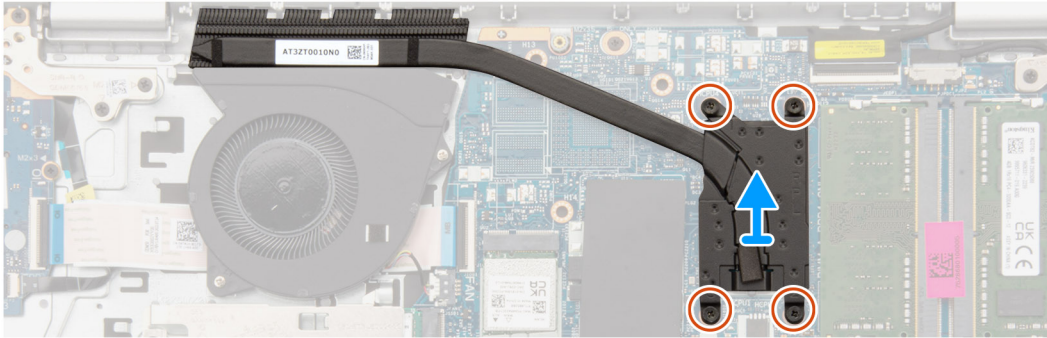
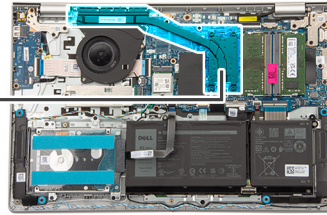

### Steps

1. Loosen the four captive screws that secure the heat sink to the system board.  
**i** **NOTE:** Loosen the four captive screws in the reverse sequential order mentioned on the heat sink [4 > 3 > 2 > 1].
2. Lift the heat sink off the system board.

## Installing the heat sink

**⚠ CAUTION:** The information in this section is intended for authorized service technicians only.

### Prerequisites

If you are replacing a component, remove the existing component before performing the installation procedure.

### About this task

**i** **NOTE:** If either the system board or the heat sink is replaced, use the thermal grease provided in the kit to ensure that thermal conductivity is achieved.

The following image indicates the location of the heat sink and provides a visual representation of the installation procedure.





4x

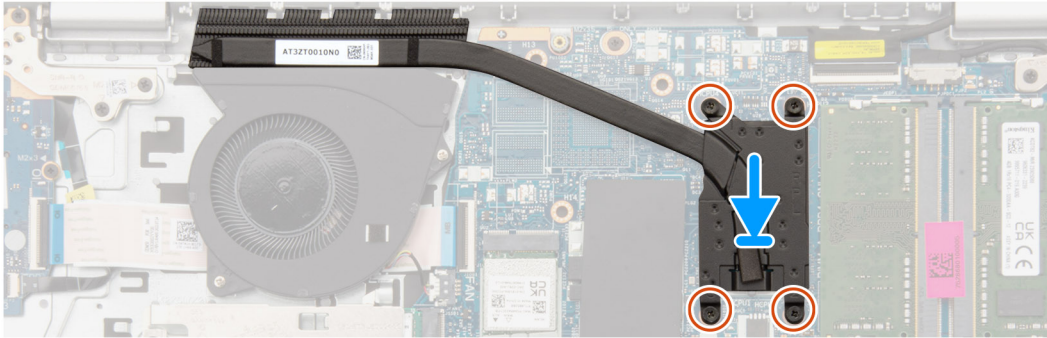
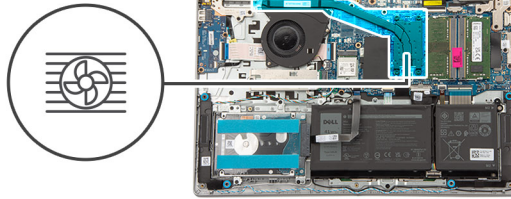

### Steps

1. Place the heat sink in the slot on the system board.
2. Align the screw holes on the heat sink to the screw holes on the system board.
3. Tighten the four captive screws to secure the heat sink to the system board.

**i** **NOTE:** Tighten the four captive screws in the sequential order mentioned on the heat sink [1 > 2 > 3 > 4].

### Next steps

1. Install the [base cover](#).
2. Follow the procedure in [After working inside your computer](#).

## Touchpad

### Removing the touchpad

**⚠ CAUTION:** The information in this section is intended for authorized service technicians only.

#### Prerequisites

1. Follow the procedure in [Before working inside your computer](#).
2. Remove the [base cover](#).
3. Remove the [3-cell battery](#) or the [4-cell battery](#), whichever applicable.

#### About this task

The following images indicate the location of the touchpad and provide a visual representation of the removal procedure.



5x  
M2x2

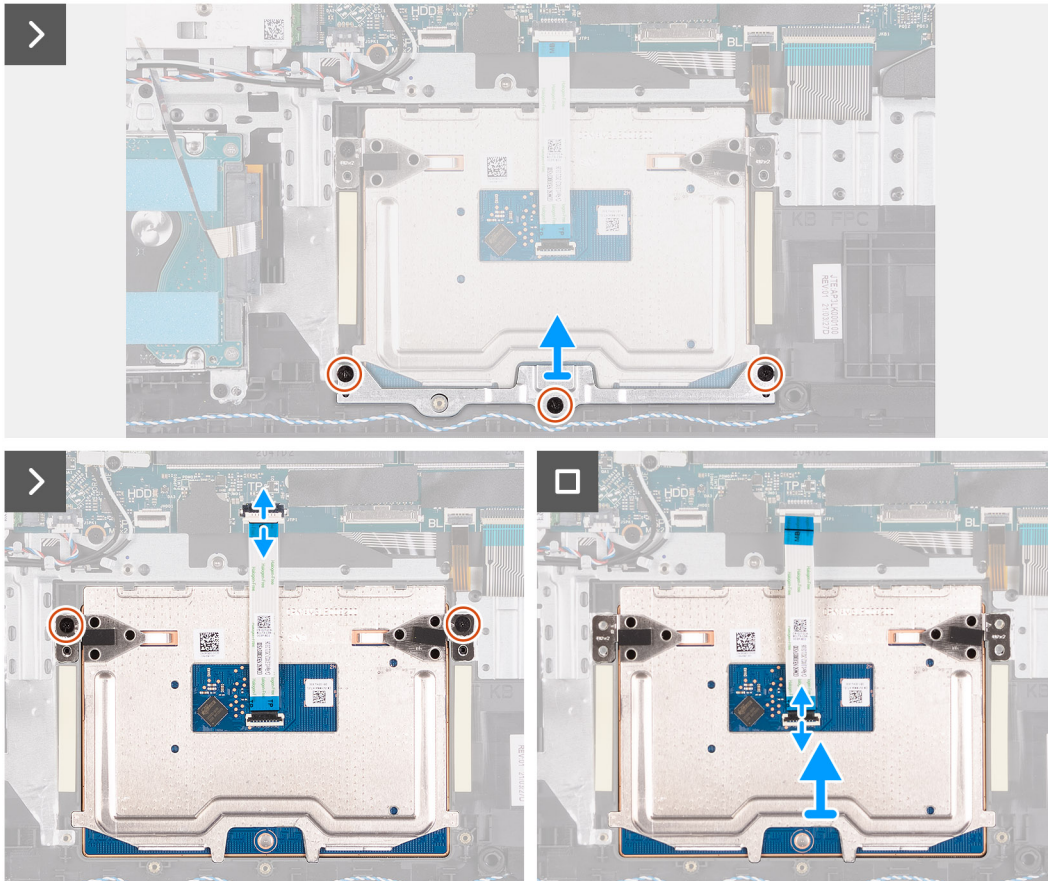
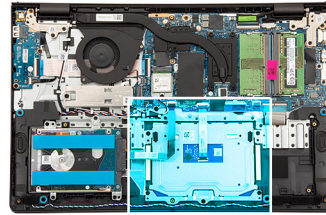

### Steps

1. Open the latch and disconnect the touchpad FFC from the connector on the system board.
2. Remove the three screws (M2x2) that secure the touchpad bracket to the palm-rest and keyboard assembly.
3. Lift the touchpad bracket off the touchpad assembly.
4. Remove the two screws (M2x2) that secure the touchpad to the palm-rest and keyboard assembly.
5. Lift the touchpad, along with the touchpad FFC, off the palm-rest and keyboard assembly.
6. Open the latch and disconnect the touchpad FFC from the connector on the touchpad.

## Installing the touchpad

**CAUTION:** The information in this section is intended for authorized service technicians only.

### Prerequisites

If you are replacing a component, remove the existing component before performing the installation procedure.

## About this task

**NOTE:** Ensure that the touchpad is aligned with the guides available on the palm-rest and keyboard assembly, and the gap on either sides of the touchpad is equal.

The following images indicate the location of the touchpad and provide a visual representation of the installation procedure.



5x  
M2x2

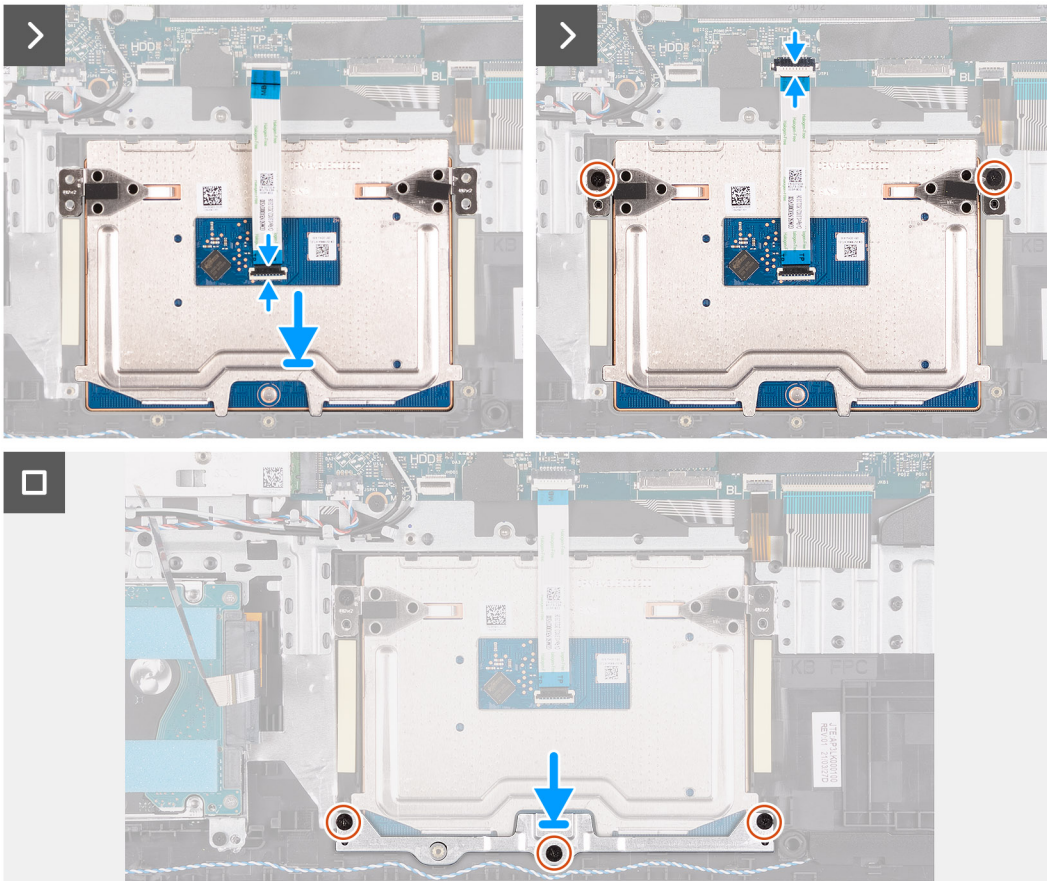
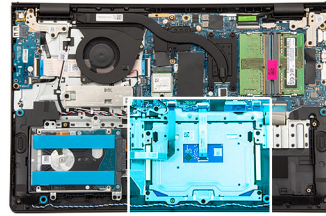

## Steps

1. Connect the touchpad FFC to the connector on the touchpad and close the latch.
2. Align and place the touchpad, along with the touchpad FFC, in the slot on the palm-rest and keyboard assembly.
3. Replace the two screws (M2x2) to secure the touchpad to the palm-rest and keyboard assembly.
4. Place the touchpad bracket in the slot on the palm-rest and keyboard assembly.
5. Align the screw holes on the touchpad bracket to the screw holes on the palm-rest and keyboard assembly.
6. Replace the three screws (M2x2) to secure the touchpad bracket to the palm-rest and keyboard assembly.
7. Connect the touchpad FFC to the connector on the system board and close the latch.

## Next steps

1. Install the [3-cell battery](#) or the [4-cell battery](#), whichever applicable.
2. Install the [base cover](#).
3. Follow the procedure in [After working inside your computer](#).



# I/O daughter-board cable

## Removing the I/O daughter-board cable

**CAUTION:** The information in this section is intended for authorized service technicians only.

### Prerequisites

1. Follow the procedure in [Before working inside your computer](#).
2. Remove the [base cover](#).
3. Remove the [fan](#).

### About this task

The following image indicates the location of the I/O daughter-board cable and provides a visual representation of the removal procedure.

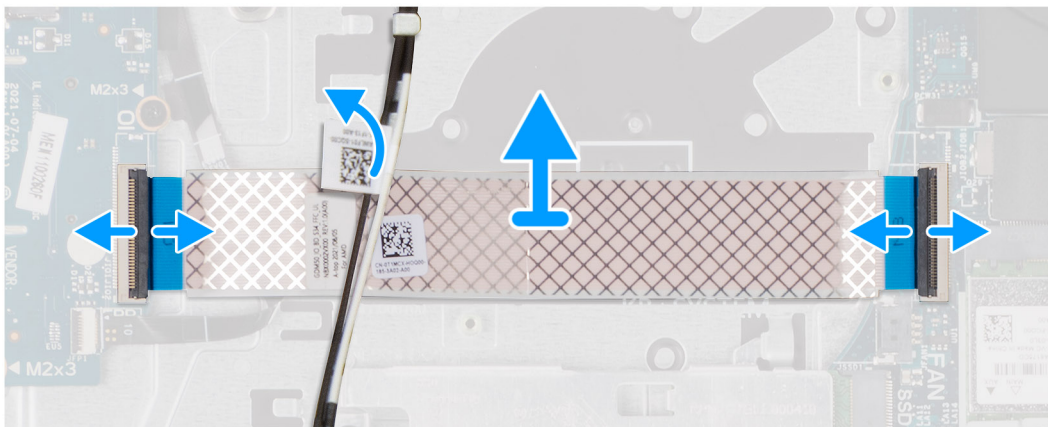
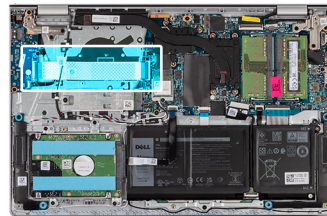

### Steps

1. Open the latch and disconnect the I/O daughter-board cable from the connector on the system board.
2. Open the latch and disconnect the I/O daughter-board cable from the connector on the I/O daughter-board.
3. Remove the I/O daughter-board cable from the palm-rest and keyboard assembly.

**NOTE:** For computers shipped with a plastic chassis, carefully slide the I/O daughter-board cable underneath the wireless-antenna cables to remove the I/O daughter-board cable.

## Installing the I/O daughter-board cable

**CAUTION:** The information in this section is intended for authorized service technicians only.

### Prerequisites

If you are replacing a component, remove the existing component before performing the installation procedure.

### About this task

The following image indicates the location of the I/O daughter-board cable and provides a visual representation of the installation procedure.

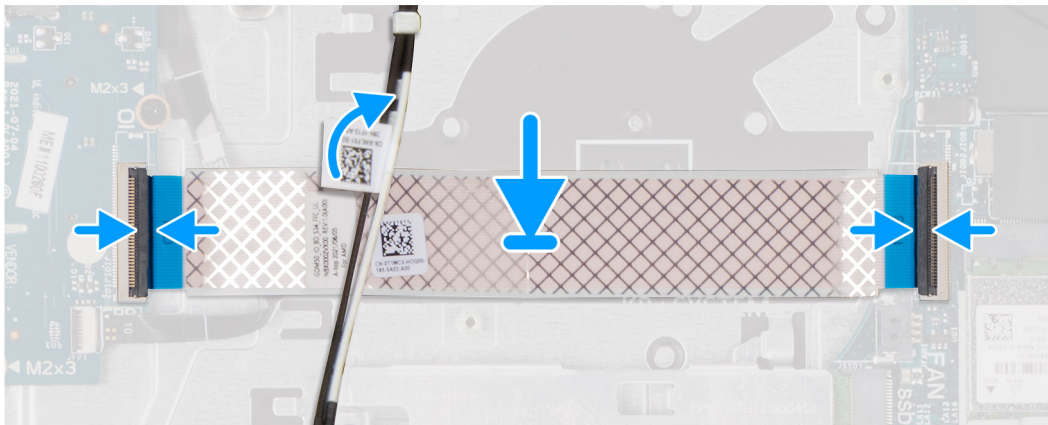
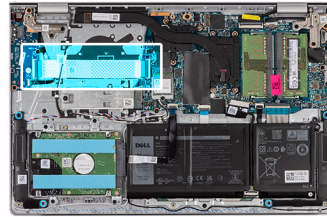

### Steps

1. Place the I/O daughter-board cable on the palm-rest and keyboard assembly.

**NOTE:** For computers shipped with a plastic chassis, carefully slide the I/O daughter-board cable underneath the wireless-antenna cables to place the I/O daughter-board cable on the palm-rest and keyboard assembly.

2. Connect the I/O daughter-board cable to the connector on the I/O daughter-board and close the latch.
3. Connect the I/O daughter-board cable to the connector on the system board and close the latch.

### Next steps

1. Install the [fan](#).
2. Install the [base cover](#).
3. Follow the procedure in [After working inside your computer](#).

## I/O daughter-board

### Removing the I/O daughter-board

**CAUTION:** The information in this section is intended for authorized service technicians only.

### Prerequisites

1. Follow the procedure in [Before working inside your computer](#).
2. Remove the [base cover](#).

### About this task

The following images indicate the location of the I/O daughter-board and provide a visual representation of the removal procedure.

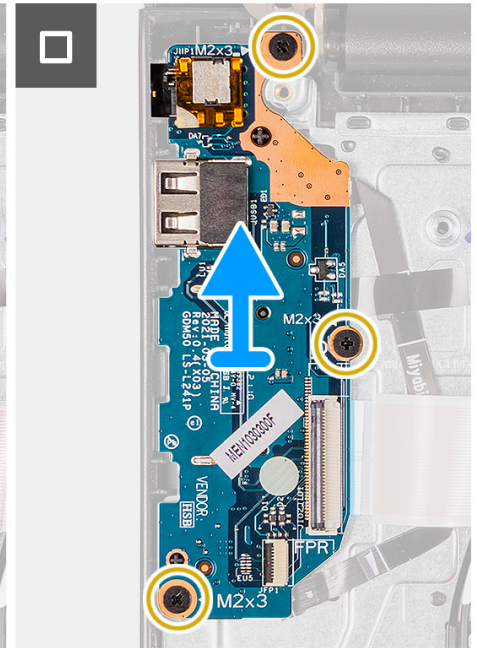
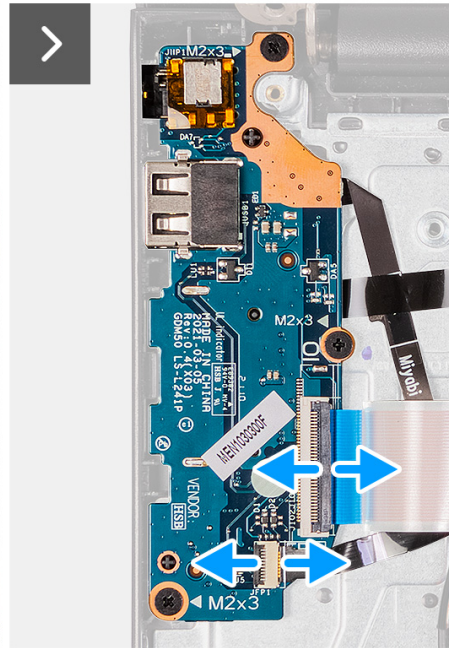
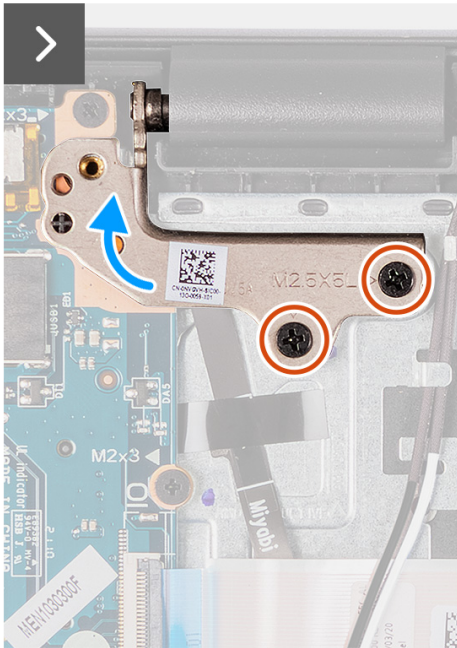
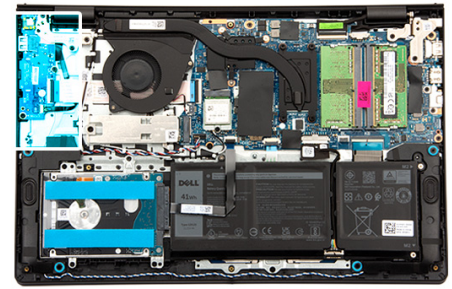

### Steps

1. Remove the two screws (M2.5x5) that secure the left display hinge to the palm-rest and keyboard assembly.
2. Using a plastic scribe, lift the left display hinge away from the palm-rest and keyboard assembly to access the I/O daughter-board.
3. Open the latch and disconnect the I/O daughter-board cable from the connector on the I/O daughter-board.
4. Open the latch and disconnect the fingerprint reader cable from the I/O daughter-board.
  - NOTE:** This step applies only to computers shipped with a fingerprint reader installed.
5. Remove the three screws (M2x3.5) that secure the I/O daughter-board to the palm-rest and keyboard assembly.
6. Carefully slide and remove the I/O daughter-board at angle, from the palm-rest and keyboard assembly, to clear the ports from the port openings.

## Installing the I/O daughter-board

**CAUTION:** The information in this section is intended for authorized service technicians only.

### Prerequisites

If you are replacing a component, remove the existing component before performing the installation procedure.



## About this task

The following images indicate the location of the I/O daughter-board and provide a visual representation of the installation procedure.

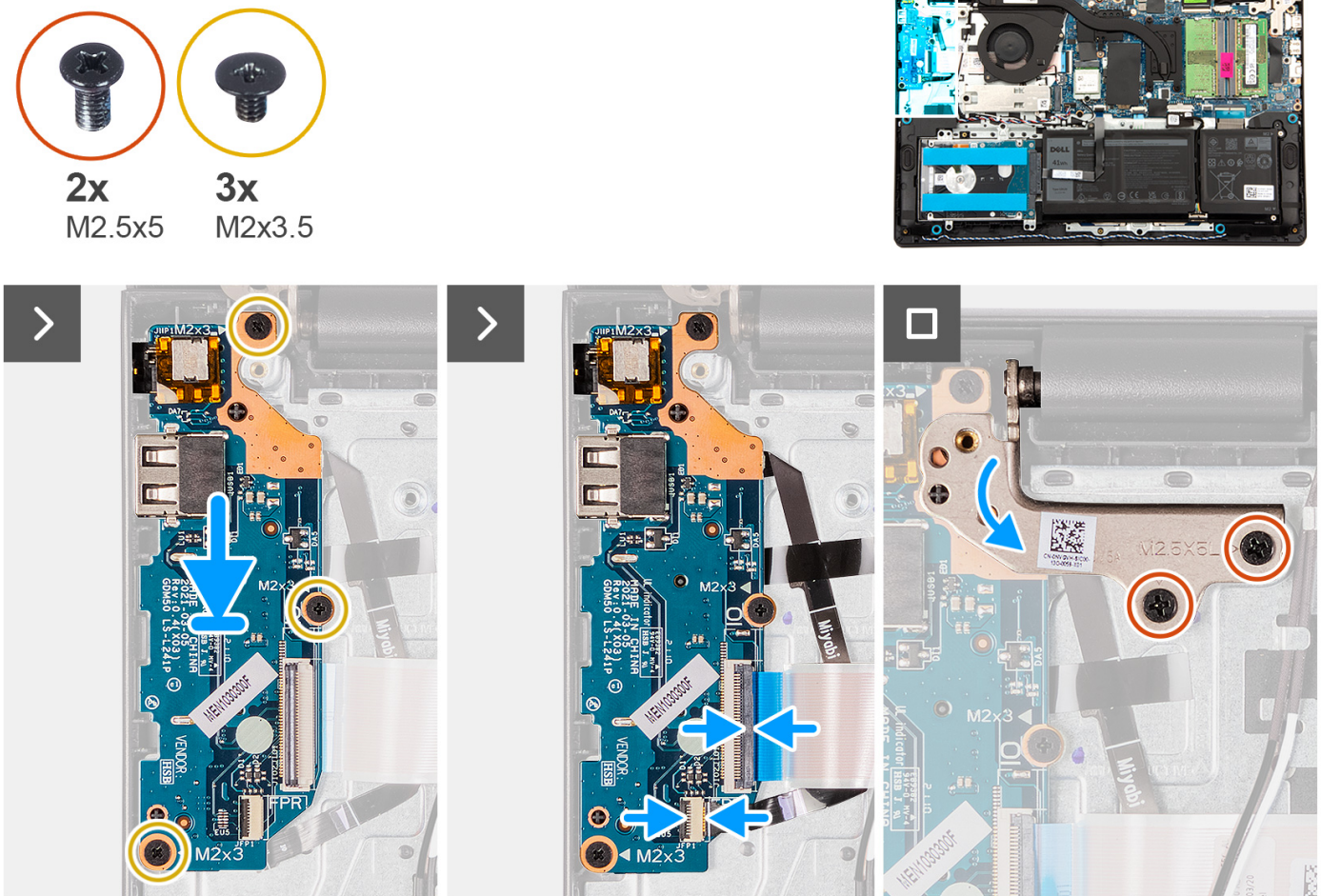

Figure 4. Installing I/O daughter-board

## Steps

1. Align the ports on the I/O daughter-board to the port openings on the palm-rest and keyboard assembly.
2. Carefully slide and place the I/O daughter-board at an angle, on the palm-rest and keyboard assembly.
3. Align the screw holes on the I/O daughter-board to the screw holes on the palm-rest and keyboard assembly.
4. Replace the three screws (M2x3.5) to secure the I/O daughter-board to the palm-rest and keyboard assembly.
5. Connect the fingerprint reader cable to the connector on the I/O daughter-board and close the latch.  
**NOTE:** This step applies only to computers shipped with a fingerprint reader installed.
6. Connect the I/O daughter-board cable to the connector on the I/O daughter-board and close the latch.
7. Close the left display hinge downwards to align the screw holes on the left display hinge to the screw holes on the I/O daughter-board and the palm-rest and keyboard assembly.
8. Replace the two screws (M2.5x5) to secure the left display hinge to the I/O daughter-board and the palm-rest and keyboard assembly.

## Next steps

1. Install the [base cover](#).
2. Follow the procedure in [After working inside your computer](#).

# Power button

## Removing the power button

**CAUTION:** The information in this section is intended for authorized service technicians only.

### Prerequisites

1. Follow the procedure in [Before working inside your computer](#).
2. Remove the [base cover](#).
3. Remove the [I/O daughter-board](#).

### About this task

The following images indicate the location of the power button and provide a visual representation of the removal procedure.

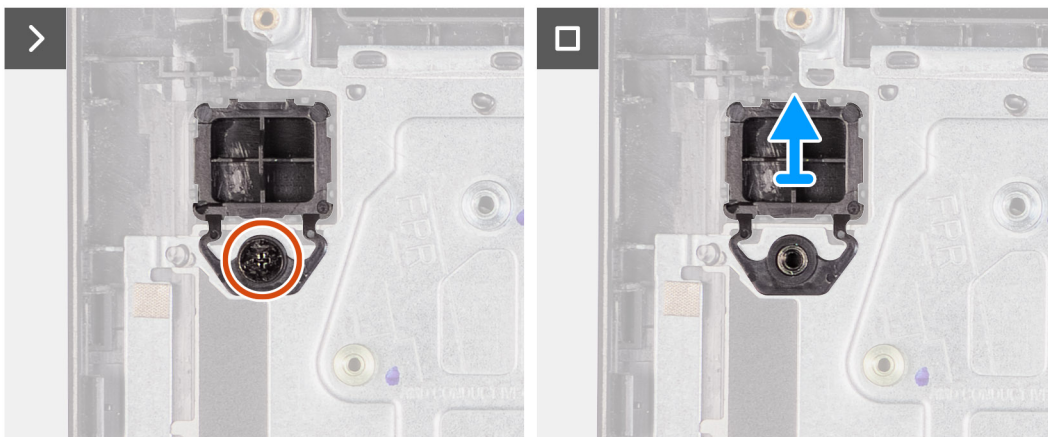
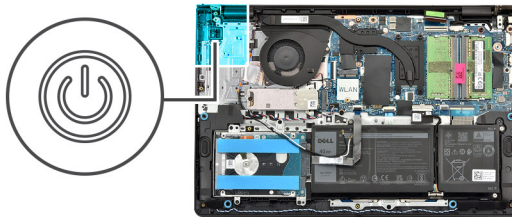

### Steps

1. Remove the screw (M2x2) that secures the power button to the palm-rest and keyboard assembly.
2. Lift the power button off the palm-rest and keyboard assembly.

## Installing the power button

**CAUTION:** The information in this section is intended for authorized service technicians only.

### Prerequisites

If you are replacing a component, remove the existing component before performing the installation procedure.

### About this task

The following images indicate the location of the power button and provide a visual representation of the installation procedure.



1x  
M2x2

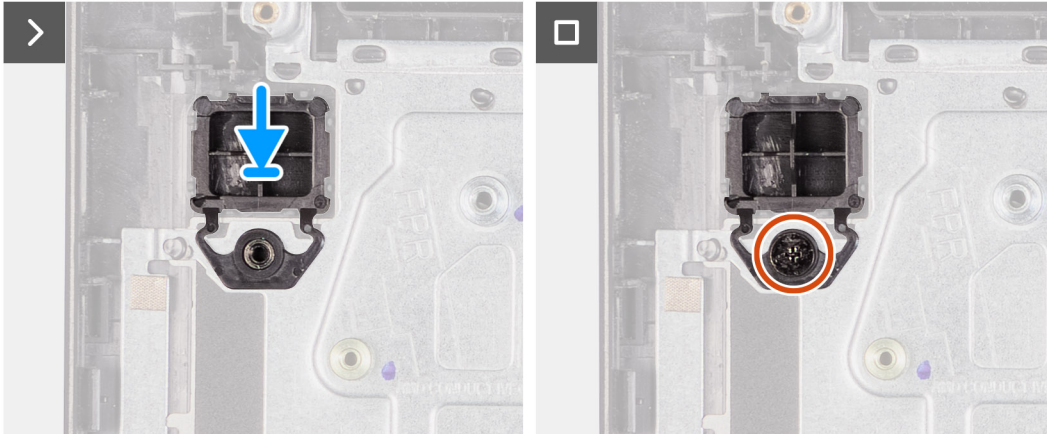
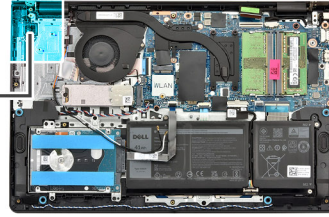

### Steps

1. Place the power button in the slot on the palm-rest and keyboard assembly.
2. Align the screw hole on the power button to the screw hole on the palm-rest and keyboard assembly.
3. Replace the screw (M2x2) to secure the power button to the palm-rest and keyboard assembly.

### Next steps

1. Install the [I/O daughter-board](#).
2. Install the [base cover](#).
3. Follow the procedure in [After working inside your computer](#).

## Power button with optional fingerprint reader

### Removing the power button with optional fingerprint reader

 **CAUTION:** The information in this section is intended for authorized service technicians only.

### Prerequisites

1. Follow the procedure in [Before working inside your computer](#).
2. Remove the [base cover](#).
3. Remove the [I/O daughter-board](#).

### About this task

 **NOTE:** This procedure applies only to computers shipped with a power button with optional fingerprint reader installed.

The following image indicates the location of the power button with optional fingerprint reader and provides a visual representation of the removal procedure.

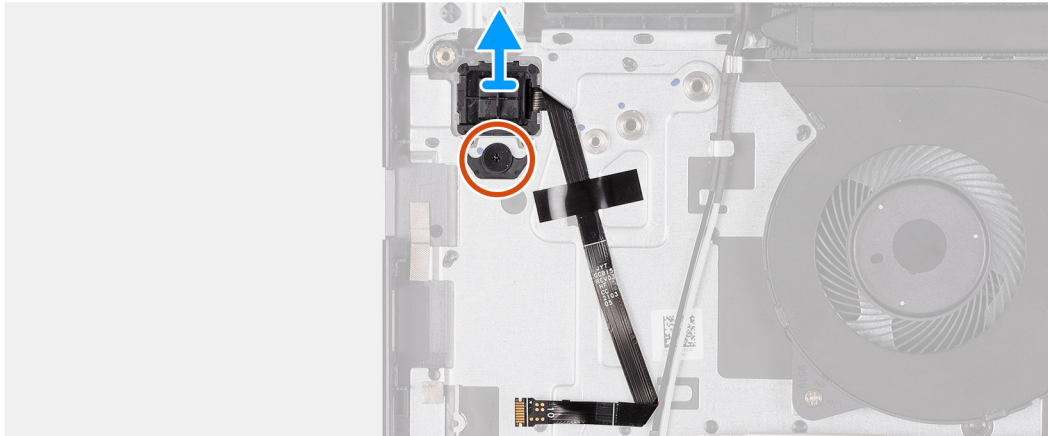
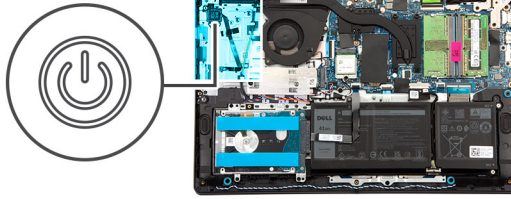

### Steps

1. Peel back the tape that secures the optional fingerprint-reader flexible printed circuit to the palm-rest and keyboard assembly.
2. Remove the screw (M2x2) that secures the power button with optional fingerprint reader to the palm-rest and keyboard assembly.
3. Lift the power button with optional fingerprint reader off the slot on the palm-rest and keyboard assembly.

## Installing the power button with optional fingerprint reader

**CAUTION:** The information in this section is intended for authorized service technicians only.

### Prerequisites

If you are replacing a component, remove the existing component before performing the installation procedure.

### About this task

**NOTE:** This procedure applies only to computers shipped with a power button with optional fingerprint reader installed.

The following image indicates the location of the power button with optional fingerprint reader and provides a visual representation of the installation procedure.





1x  
M2x2

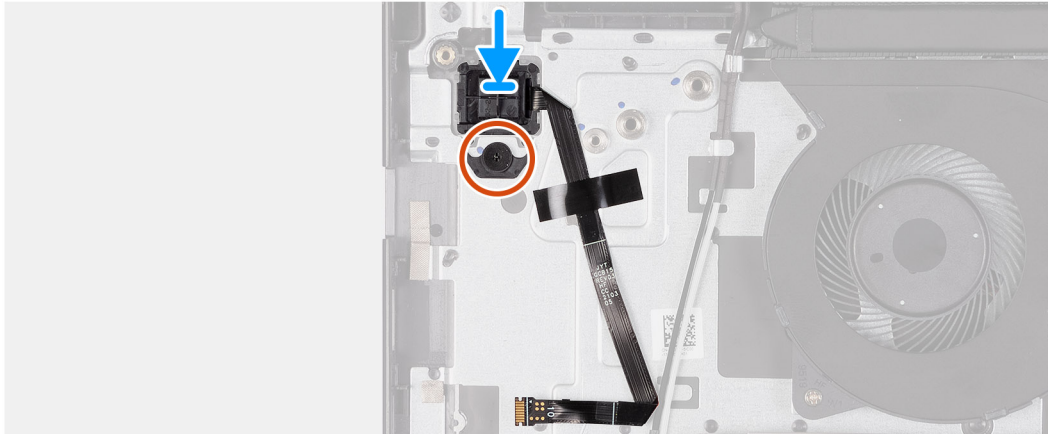
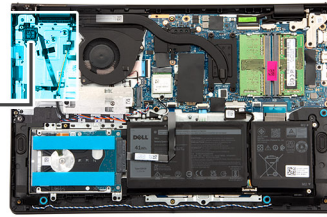

### Steps

1. Place the power button with optional fingerprint reader in the slot on the palm-rest and keyboard assembly.
2. Align the screw hole on the power button with optional fingerprint reader to the screw hole on the palm-rest and keyboard assembly.
3. Replace the screw (M2x2) to secure the power button with optional fingerprint reader to the palm-rest and keyboard assembly.
4. Adhere the tape to secure the optional fingerprint-reader flexible printed circuit to the palm-rest and keyboard assembly.

### Next steps

1. Install the [I/O daughter-board](#).
2. Install the [base cover](#).
3. Follow the procedure in [After working inside your computer](#).

## Power-adapter port

### Removing the power-adapter port

 **CAUTION:** The information in this section is intended for authorized service technicians only.

#### Prerequisites

1. Follow the procedure in [Before working inside your computer](#).
2. Remove the [base cover](#).

#### About this task

The following images indicate the location of the power-adapter port and provide a visual representation of the removal procedure.



2x  
M2.5x5

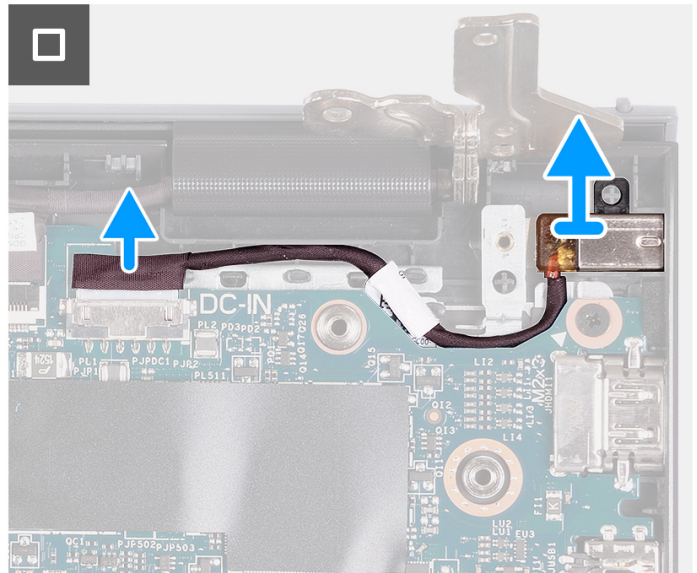
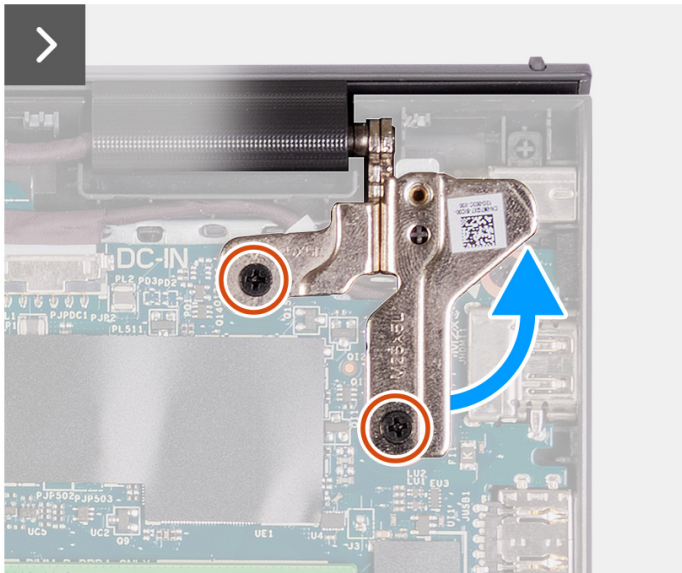
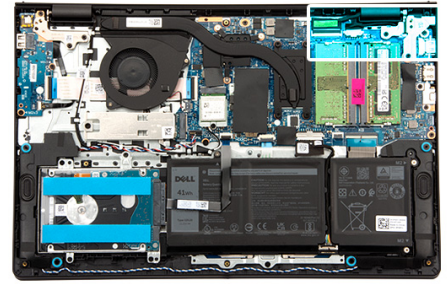

### Steps

1. Remove the two screws (M2.5x5) that secure the right display hinge to the system board and the palm-rest and keyboard assembly.
2. Using a plastic scribe, lift the right display hinge away from the palm-rest and keyboard assembly to access the power-adapter port.
3. Disconnect the power-adapter port cable from the connector on the system board.
4. Remove the power-adapter port from the slot on the palm-rest and keyboard assembly.

**NOTE:** The power-adapter port is secured in place by the right display hinge. There is no screw, tape, or adhesives securing the power-adapter port to the palm rest. As a result, technicians should take note of whether the power-adapter port has fallen out of the computer during subsequent removal procedures.

## Installing the power-adapter port

**CAUTION:** The information in this section is intended for authorized service technicians only.

### Prerequisites

If you are replacing a component, remove the existing component before performing the installation procedure.

### About this task

The following images indicate the location of the power-adapter port and provide a visual representation of the installation procedure.





2x  
M2.5x5

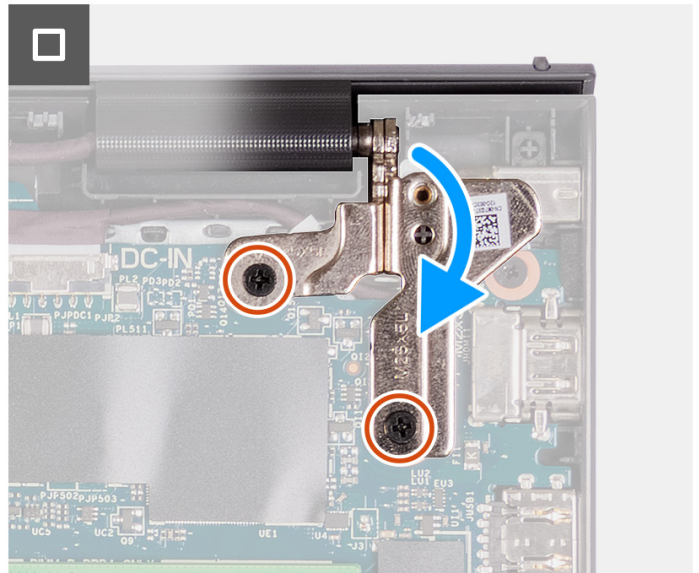
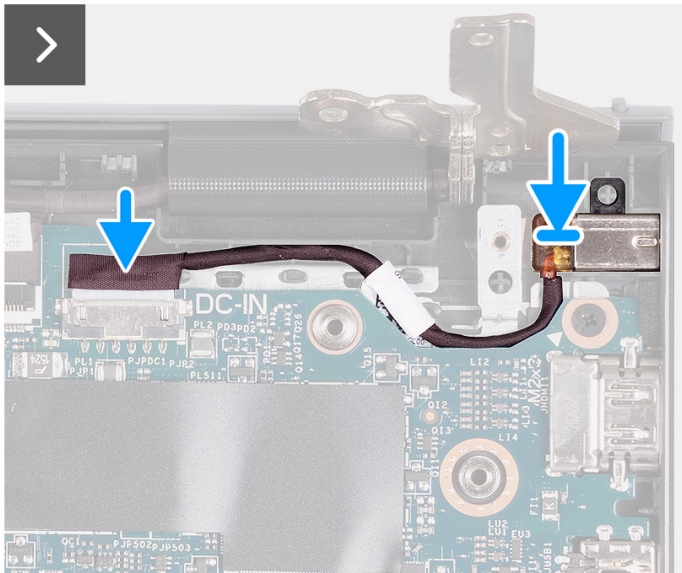
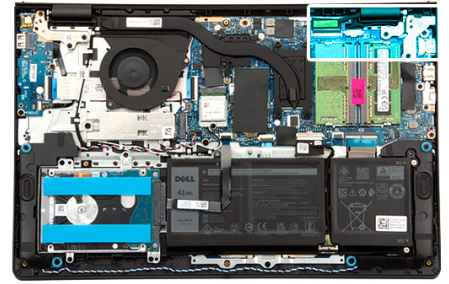

### Steps

1. Align and place the power-adaptor port in the slot on the palm-rest and keyboard assembly.  
**i** **NOTE:** The power-adaptor port is secured in place by the right display hinge. There is no screw, tape, or adhesives securing the power-adaptor port to the palm rest. As a result, technicians should take note of whether the power-adaptor port has fallen out of the computer during subsequent removal procedures.
2. Connect the power-adaptor port cable to the connector on the system board.
3. Close the right display hinge downwards to align the screw holes on the right display hinge to the screw holes on the system board and the palm-rest and keyboard assembly.
4. Replace the two screws (M2.5x5) to secure the right display hinge to the system board and the palm-rest and keyboard assembly.

### Next steps

1. Install the [base cover](#).
2. Follow the procedure in [After working inside your computer](#).

## Display assembly

### Removing the display assembly

**⚠ CAUTION:** The information in this section is intended for authorized service technicians only.

**⚠ CAUTION:** The maximum operating angle for the display-panel hinge is 135 degrees.

### Prerequisites

1. Follow the procedure in [Before working inside your computer.](#)
2. Remove the [base cover.](#)
3. Remove the [wireless card.](#)

### About this task

The following images indicate the location of the display assembly and provide a visual representation of the removal procedure.



**4x**  
M2.5x5

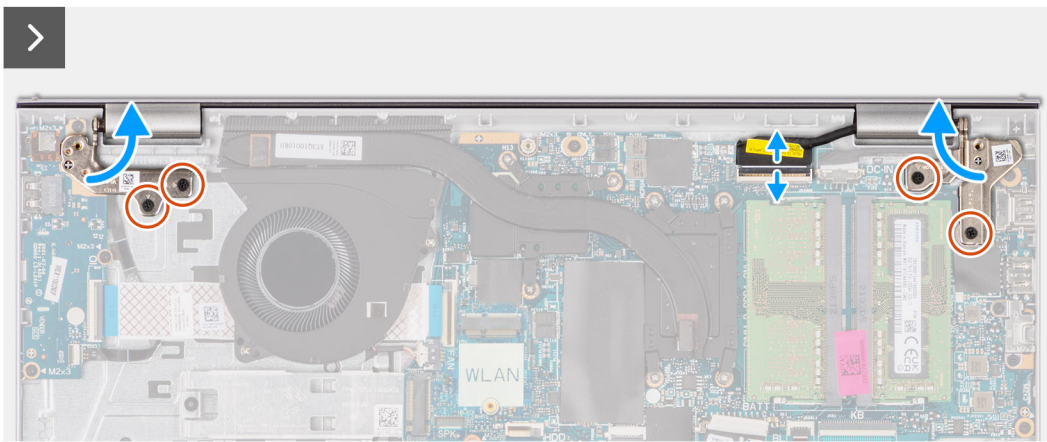
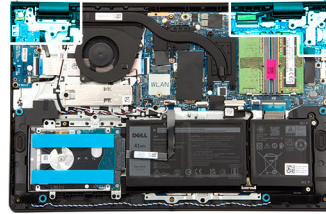

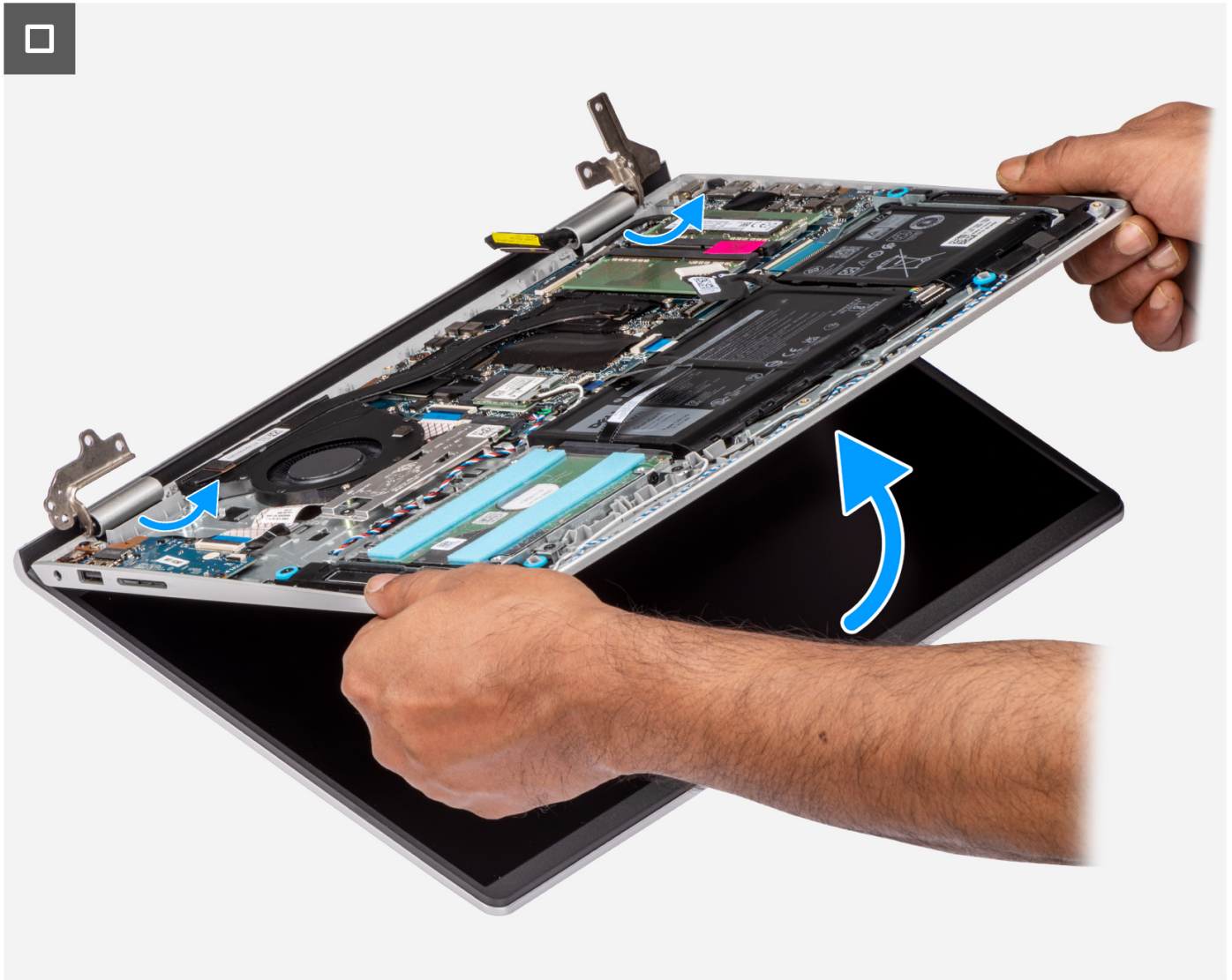



## Steps

1. Disconnect the speaker cable from the connector on the system board.

**i** **NOTE:** This step applies only to computers shipped with a plastic chassis.

2. Disconnect the display cable from the connector on the system board.
3. Unroute the wireless-antenna cable from the routing guides on the palm-rest and keyboard assembly.

**i** **NOTE:** This step applies only to computers shipped with a plastic chassis.

4. Remove the four screws (M2.5x5) that secure the display hinges to the palm-rest and keyboard assembly.
5. Using a plastic scribe, lift the left and right hinges away from the palm-rest and keyboard assembly.
6. Lift the palm-rest and keyboard assembly at an angle to free it from the hinges and remove it from the display assembly.

**i** **NOTE:** For computers shipped with an aluminum chassis, the display assembly is a Hinge-Up Design (HUD) assembly and cannot be further disassembled once it is removed from the palm-rest and keyboard assembly. If any components in the display assembly are malfunctioning and are required to be replaced, replace the entire display assembly.

**i** **NOTE:** The power-adaptor port is secured in place by the right display hinge. There is no screw, tape, or adhesives securing the power-adaptor port to the palm-rest. As a result, technicians should take note of whether the power-adaptor port has fallen out of the computer during subsequent removal procedures.



## Installing the display assembly

**CAUTION:** The information in this section is intended for authorized service technicians only.

**CAUTION:** The maximum operating angle for the display-panel hinge is 135 degrees.

### Prerequisites

If you are replacing a component, remove the existing component before performing the installation procedure.

### About this task

**NOTE:** Ensure that the display hinges are opened to the maximum before replacing the display assembly on the palm-rest and keyboard assembly.

The following images indicate the location of the display assembly and provide a visual representation of the installation procedure.



4x  
M2.5x5

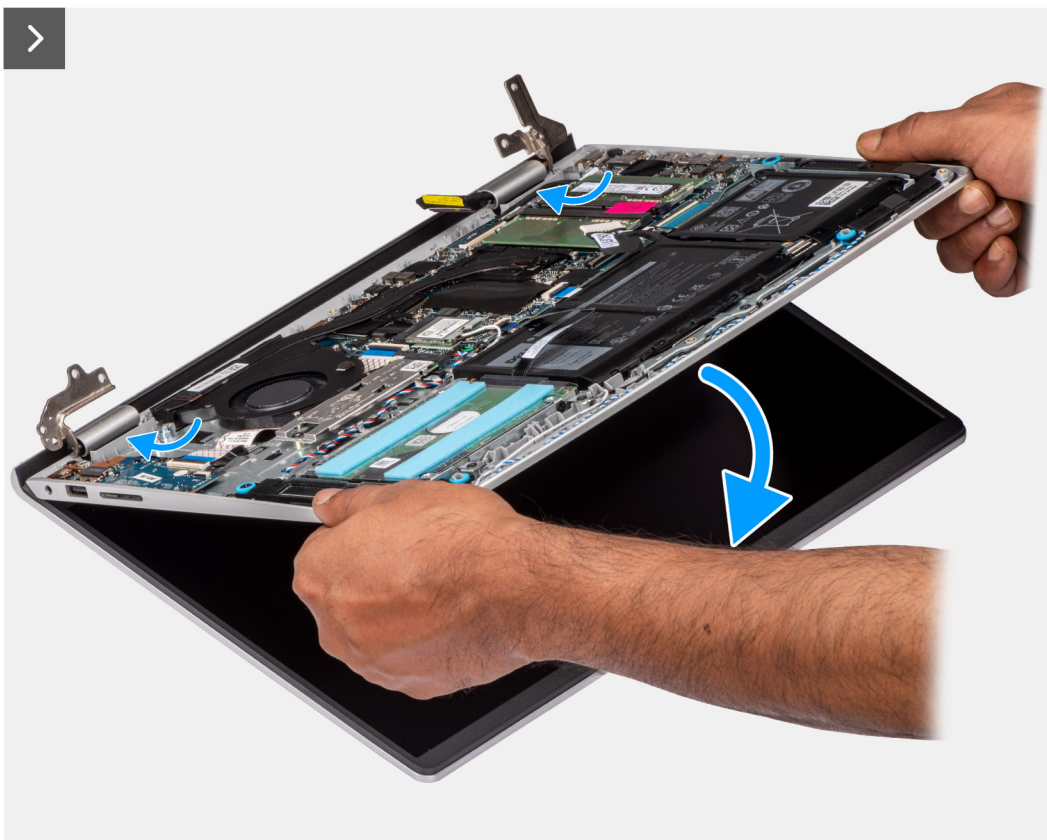
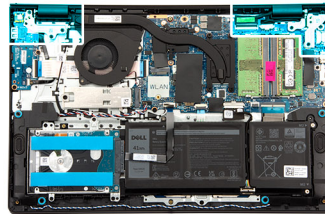

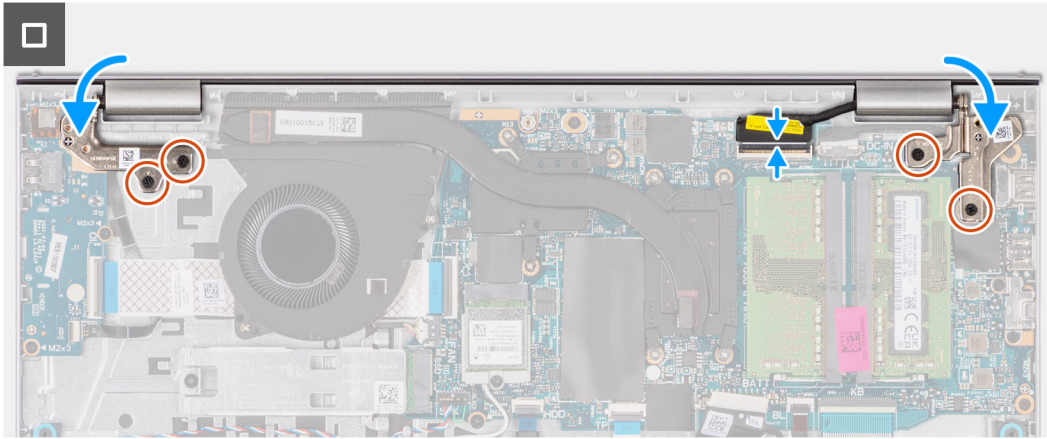

## Steps

1. Place the display assembly on a clean and flat surface.
2. Slide the palm-rest and keyboard assembly at an angle and place the palm-rest and keyboard assembly on the display assembly.
  - i** **NOTE:** The power-adapter port is secured in place by the right display hinge. There is no screw, tape, or adhesives securing the power-adapter port to the palm-rest. As a result, technicians should take note of whether the power-adapter port has fallen out of the computer during subsequent removal procedures.
3. Gently press down on the display hinges to align the screw holes on the display hinges with the screw holes on the palm-rest and keyboard assembly.
4. Replace the four screws (M2.5x5) to secure the display hinges to the palm-rest and keyboard assembly.
5. Route the wireless-antenna cables through the routing guides on the palm-rest and keyboard assembly.
  - i** **NOTE:** This step applies only to computers shipped with a plastic chassis.



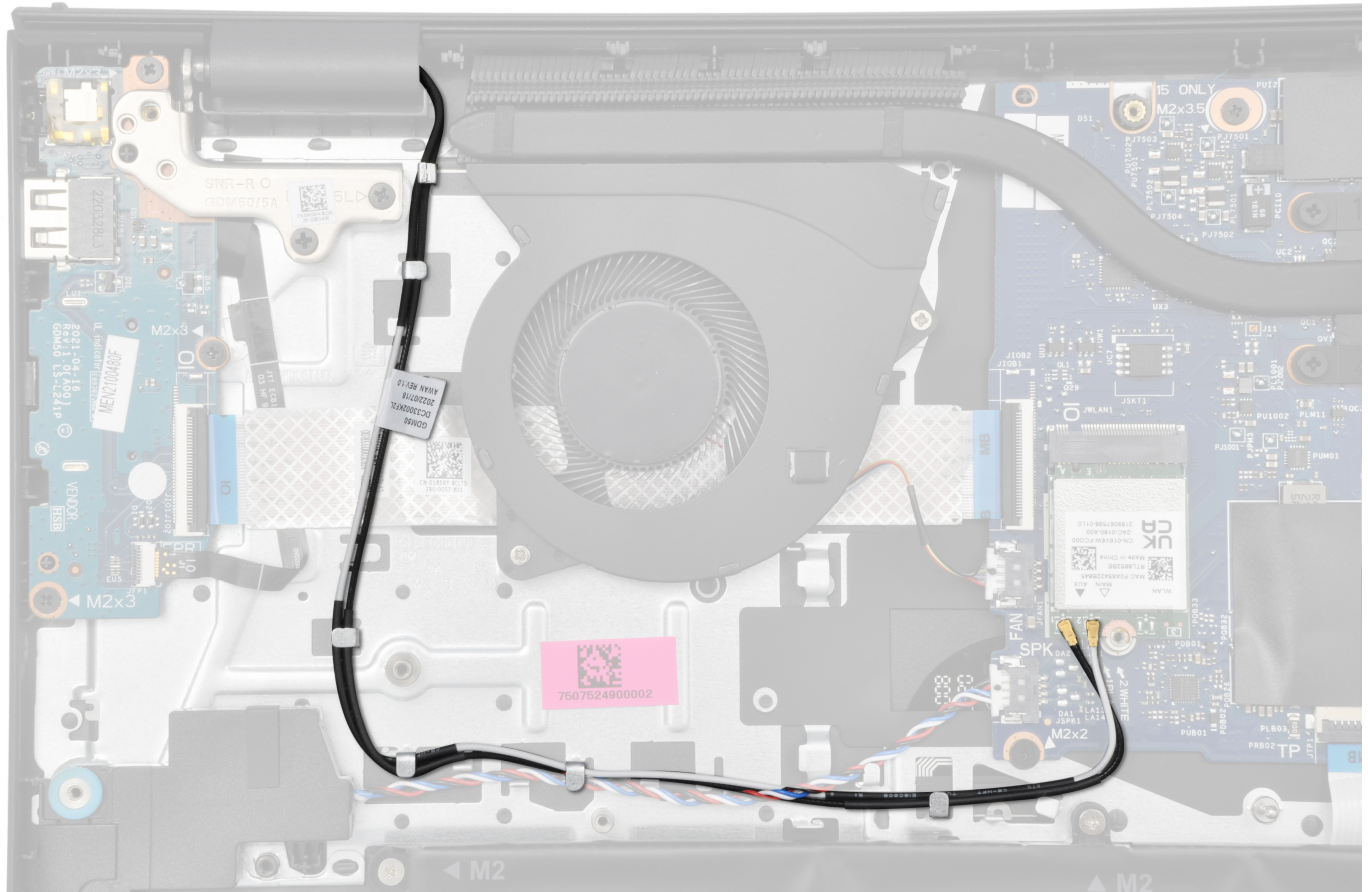

6. Route the speaker cable through the routing guides on the palm-rest and keyboard assembly.

**i** **NOTE:** This step applies only to computers shipped with a plastic chassis.

7. Connect the speaker cable to the connector on the system board.

**i** **NOTE:** This step applies only to computers shipped with a plastic chassis.

8. Connect the display cable to the connector on the system board.

#### Next steps

1. Install the [wireless card](#).

**i** **NOTE:** This procedure applies only to systems shipped with a plastic chassis.

2. Install the [base cover](#).

3. Follow the procedure in [After working inside your computer](#).

## Display hinge caps

### Removing the display hinge caps

**⚠ CAUTION:** The information in this section is intended for authorized service technicians only.

#### Prerequisites

1. Follow the procedure in [Before working inside your computer](#).

2. Remove the [base cover](#).
3. Remove the [wireless card](#).
4. Remove the [display assembly](#).

**About this task**

**NOTE:** This procedure applies only to computers with a plastic chassis.

The following images indicate the location of the display hinge caps and provide a visual representation of the removal procedure.

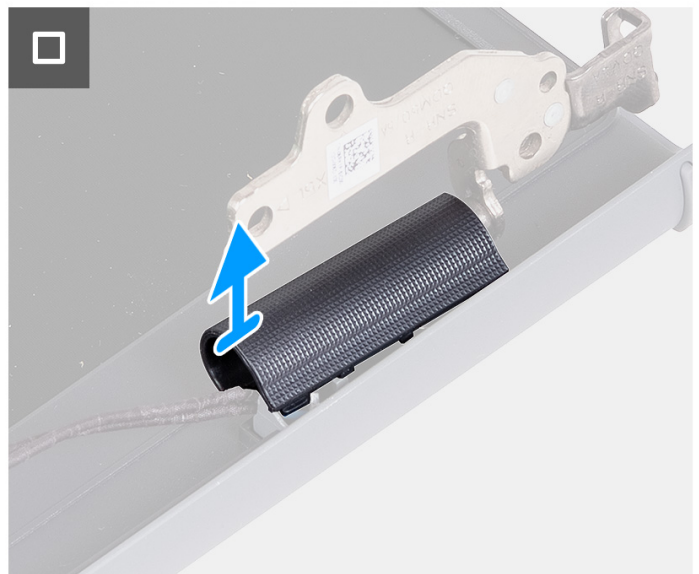
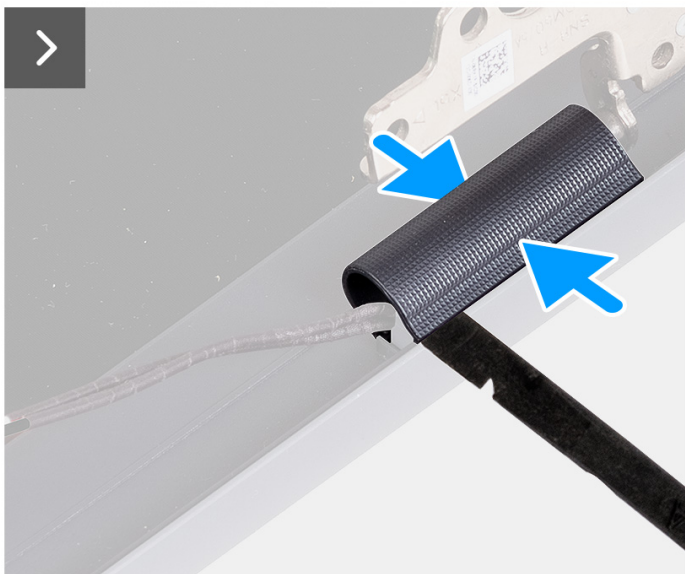
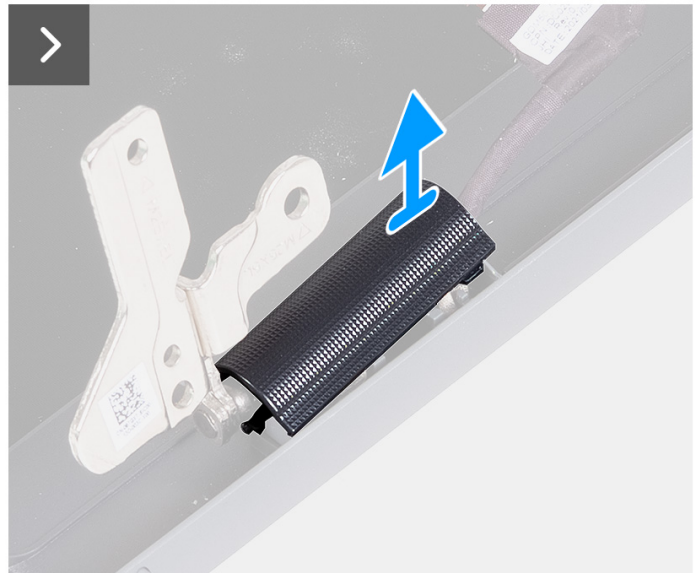
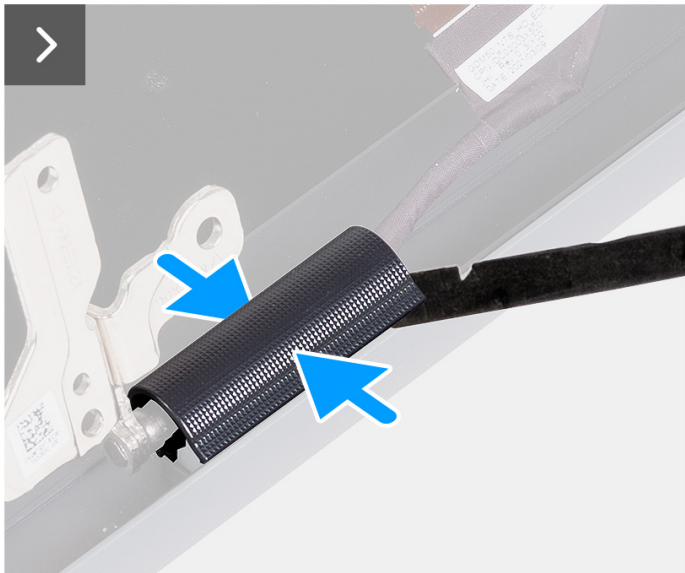

## Steps

1. Place the display assembly on a clean, flat surface and gently open the display hinges to at least 90 degrees.



2. Using a plastic scribe, pry open the left display-hinge cap from its right side and remove it from the left display hinge.
3. Using a plastic scribe, pry open the right display-hinge cap from its left side and remove it from the right display hinge.



## Installing the display hinge caps

**CAUTION:** The information in this section is intended for authorized service technicians only.

### Prerequisites

If you are replacing a component, remove the existing component before performing the installation procedure.



## About this task

**NOTE:** This procedure applies only to computers with a plastic chassis.

The following images indicate the location of the display hinge caps and provide a visual representation of the installation procedure.

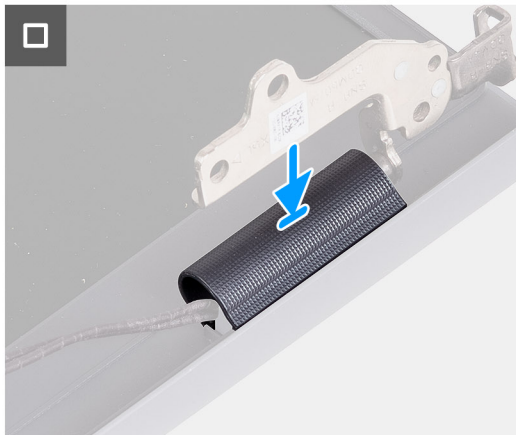
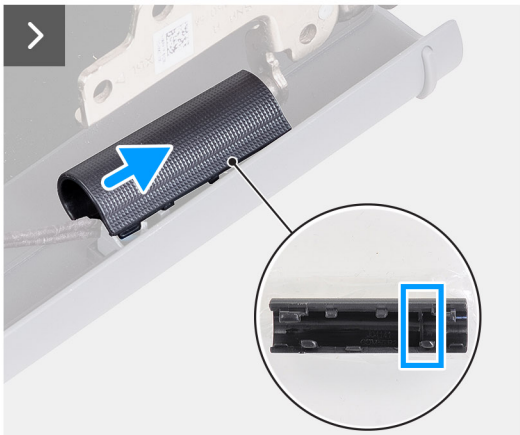
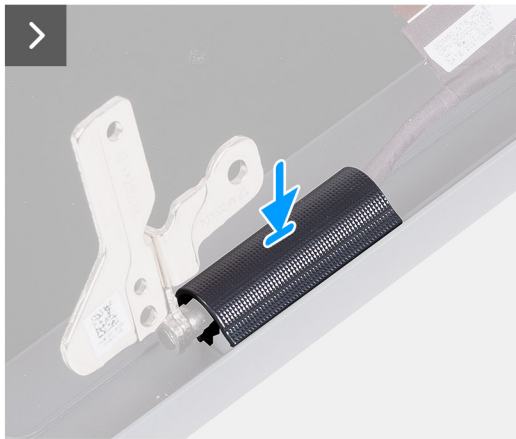
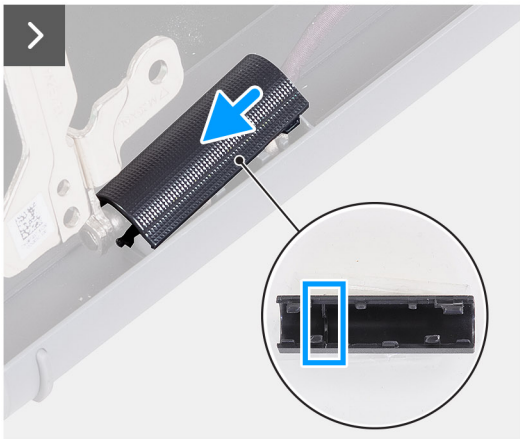

## Steps

1. Align the rib, inside the right display-hinge cap, to the left-outer side of the right display hinge.
2. Push the right display-hinge cap down on the right display hinge, until it clicks in place.
3. Align the rib, inside the left display-hinge cap, to the right-outer side of the left display hinge.
4. Push the left display-hinge cap down on the right display hinge, until it clicks in place.

## Next steps

1. Install the [display assembly](#).
2. Install the [wireless card](#).
3. Install the [base cover](#).
4. Follow the procedure in [After working inside your computer](#).

# Display bezel

## Removing the display bezel

**CAUTION:** The information in this section is intended for authorized service technicians only.

### Prerequisites

1. Follow the procedure in [Before working inside your computer](#).
2. Remove the [base cover](#).
3. Remove the [wireless card](#).
4. Remove the [display assembly](#).
5. Remove the [display hinge caps](#).

### About this task

**NOTE:** This procedure applies only to computers with a plastic chassis.

The following image indicates the location of the display bezel and provides a visual representation of the removal procedure.

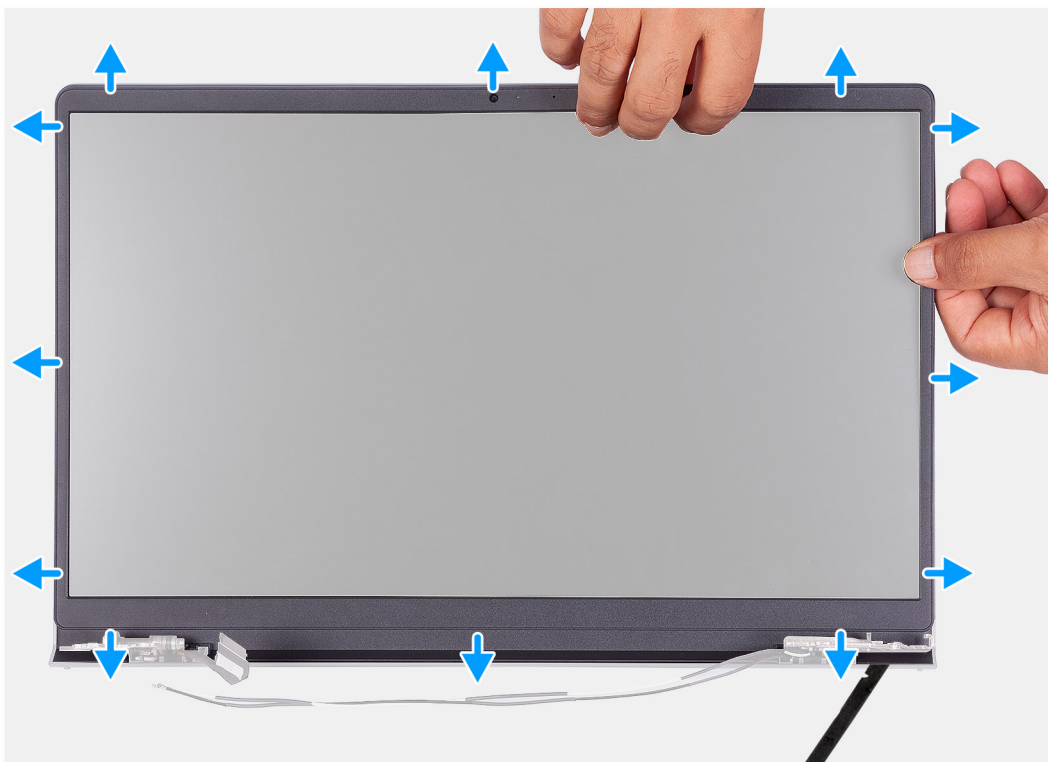

### Steps

1. Using a plastic scribe, pry open the display bezel from the outer edge of openings at the bottom side of the display assembly, near the display hinges.

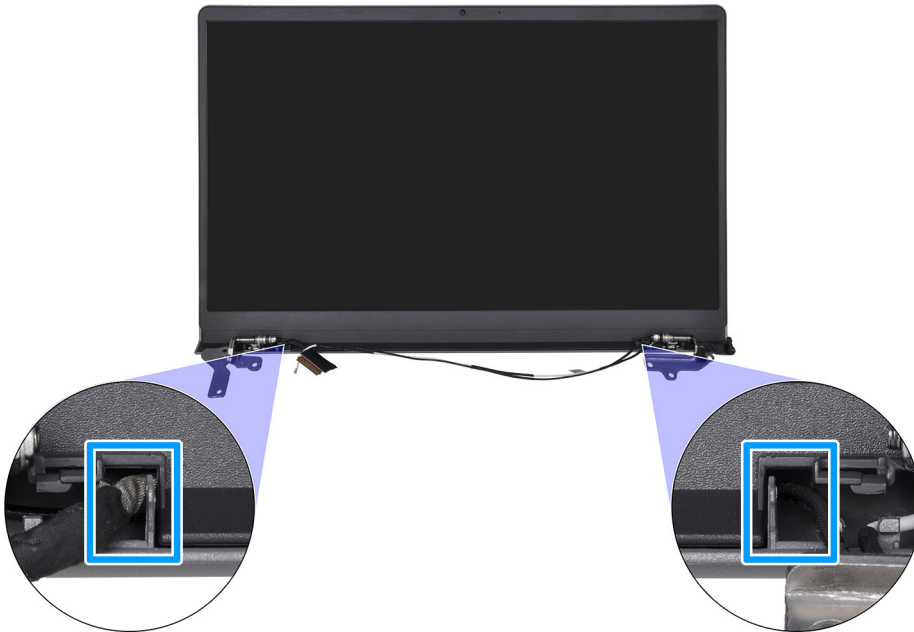

2. Carefully pry open the outer edge of the bottom side of the display bezel.
3. Using the plastic scribe, pry open the outside edge of the left, right, and top sides of the display bezel.



4. Lift and remove the display bezel from the display assembly.

**CAUTION:** DO NOT use a plastic scribe or any other objects to pry up the display bezel in the manner shown below, as the pressure applied on the display panel by the scribe may damage the display panel.





## Installing the display bezel

**CAUTION:** The information in this section is intended for authorized service technicians only.

### Prerequisites

If you are replacing a component, remove the existing component before performing the installation procedure.

### About this task

**NOTE:** This procedure applies only to computers with a plastic chassis.

The following image indicates the location of the display bezel and provides a visual representation of the installation procedure.



### Steps

1. Place the display assembly on a clean and flat surface.
2. Align and place the display bezel on the display assembly.
3. Starting from the top corner, press on the display bezel and work around the entire bezel until it clicks onto the display assembly.

### Next steps

1. Install the [display hinge caps](#).
2. Install the [display assembly](#).
3. Install the [wireless card](#).
4. Install the [base cover](#).
5. Follow the procedure in [After working inside your computer](#).

## Display hinges

### Removing the display hinges

 **CAUTION:** The information in this section is intended for authorized service technicians only.

## Prerequisites

1. Follow the procedure in [Before working inside your computer](#).
2. Remove the [base cover](#).
3. Remove the [wireless card](#).
4. Remove the [display assembly](#).
5. Remove the [display hinge caps](#).
6. Remove the [display bezel](#).

## About this task

**NOTE:** This procedure applies only to computers with a plastic chassis.

The following images indicate the location of the display hinges and provide a visual representation of the removal procedure.



**6x**  
M2.5x3.8

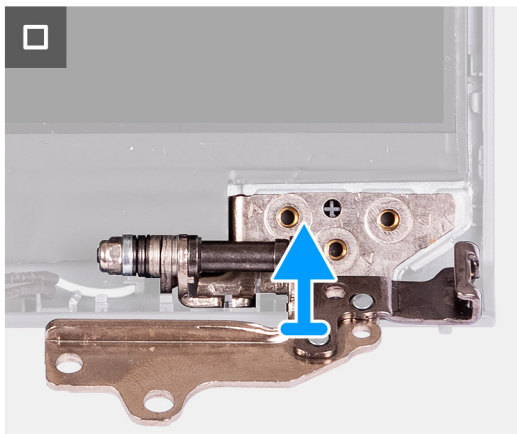
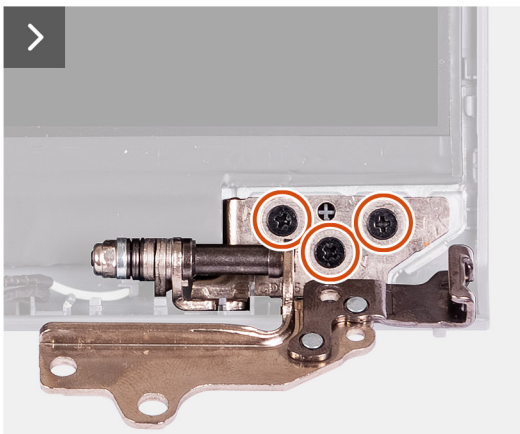
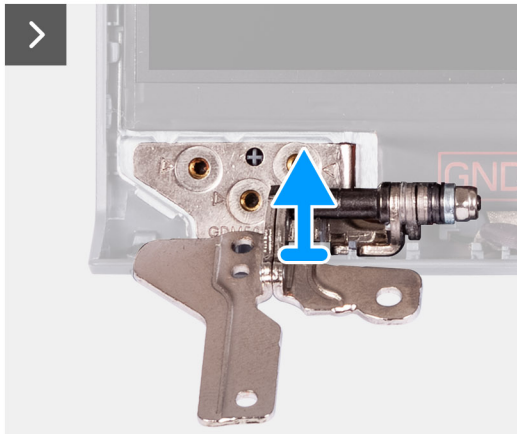

## Steps

1. Remove the three screws (M2.5x3.8) that secure the left display hinge to the display panel and back cover.
2. Lift and remove the left display hinge from the display assembly.
3. Remove the three screws (M2.5x3.8) that secure the right display hinge to the display panel and back cover.
4. Lift and remove the right display hinge from the display assembly.

## Installing the display hinges

**CAUTION:** The information in this section is intended for authorized service technicians only.

### Prerequisites

If you are replacing a component, remove the existing component before performing the installation procedure.

### About this task

**NOTE:** This procedure applies only to computers with a plastic chassis.

The following images indicate the location of the display hinges and provide a visual representation of the installation procedure.



**6x**  
M2.5x3.8

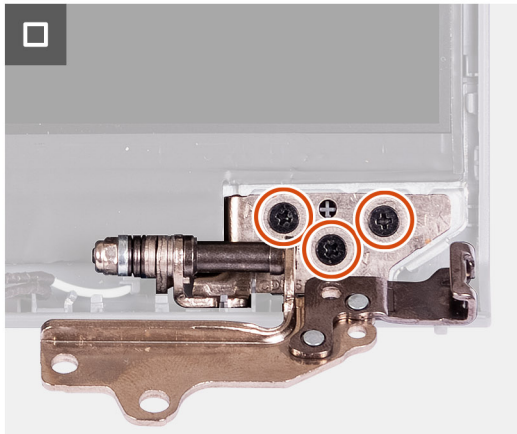
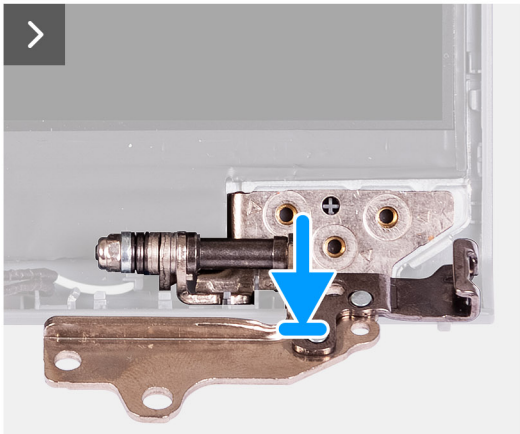
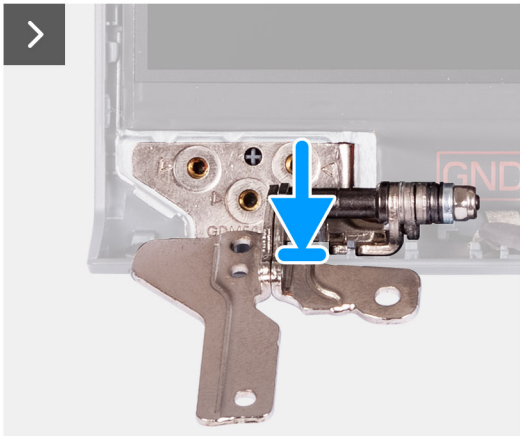

### Steps

1. Align and place the left display hinge on the display assembly.
2. Replace the three screws (M2.5x3.8) to secure the left display hinge to the display panel and back cover.
3. Align and place the right display hinge on the display assembly.
4. Replace the three screws (M2.5x3.8) to secure the right display hinge to the display panel and back cover.

### Next steps

1. Install the [display bezel](#).
2. Install the [display hinge caps](#).
3. Install the [display assembly](#).
4. Install the [wireless card](#).
5. Install the [base cover](#).
6. Follow the procedure in [After working inside your computer](#).

## Display panel

### Removing the display panel

 **CAUTION:** The information in this section is intended for authorized service technicians only.

#### Prerequisites

1. Follow the procedure in [Before working inside your computer](#).
2. Remove the [base cover](#).
3. Remove the [wireless card](#).
4. Remove the [display assembly](#).
5. Remove the [display hinge caps](#).
6. Remove the [display bezel](#).
7. Remove the [display hinges](#).

#### About this task

 **NOTE:** This procedure applies only to computers with a plastic chassis.

The following images indicate the location of the display panel and provide a visual representation of the removal procedure.





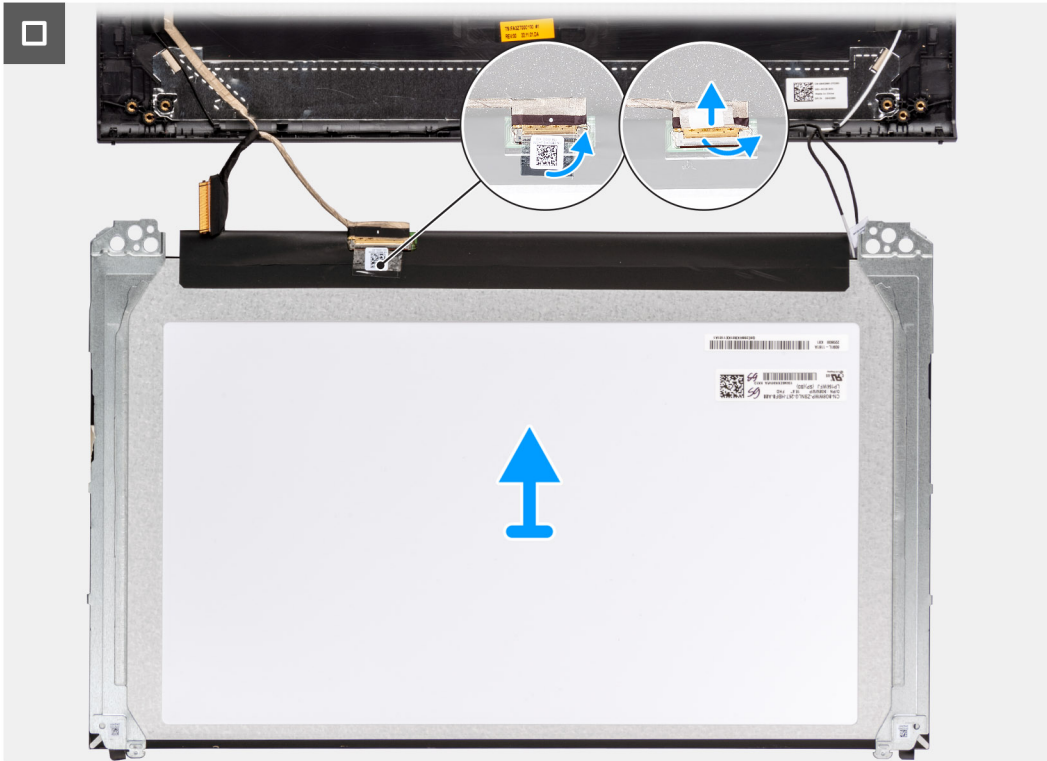

### Steps

1. Using a plastic scribe, pry the display panel from the bottom-right corner.



2. Using your hands, gently pry the display panel from the tabs along the right side of the display back-cover and antenna assembly.

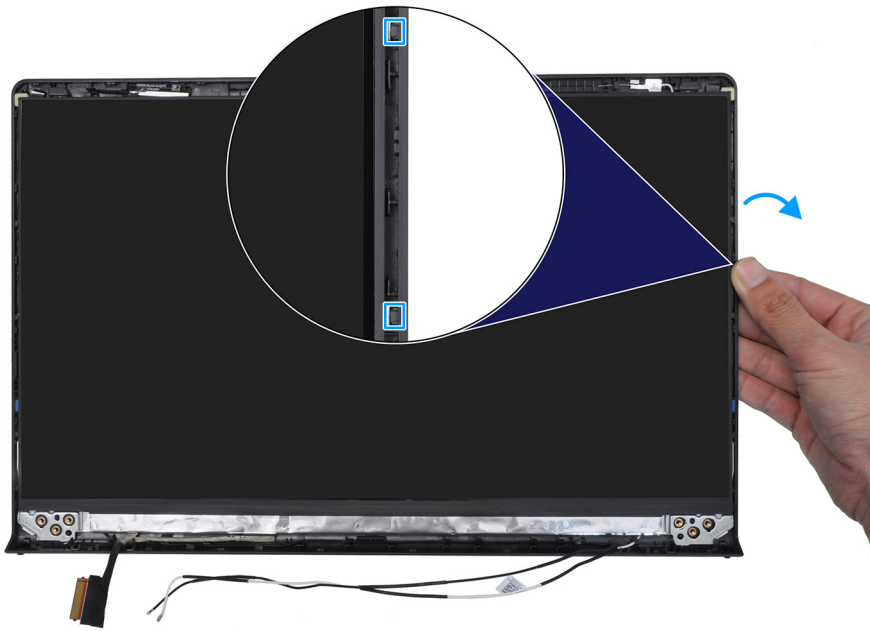

3. Repeat step 1 and 2 for the left side of the display panel assembly.

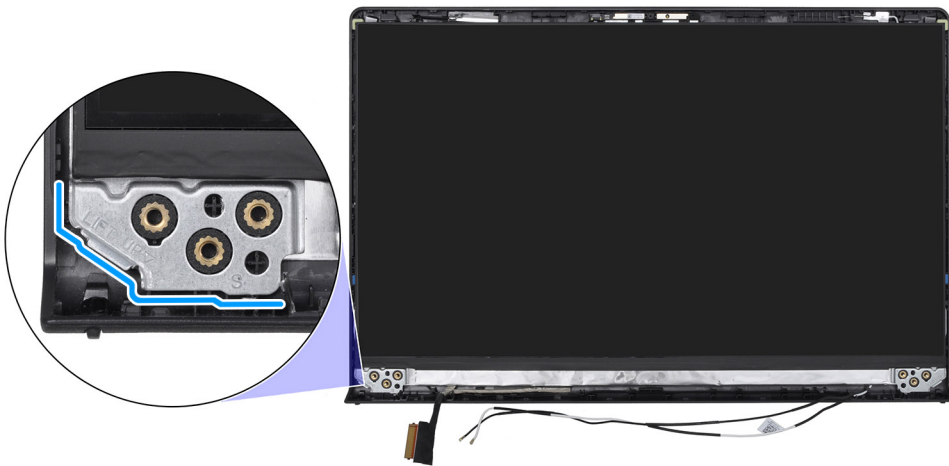

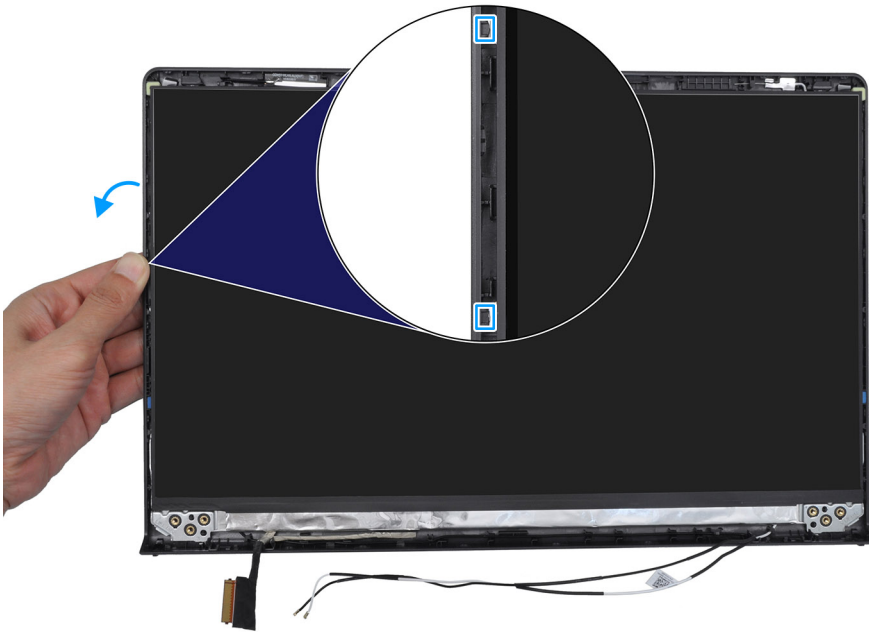

4. Lift the bottom side of the display panel and slide it downward to release the display brackets from the slots at the top side of the display back-cover.

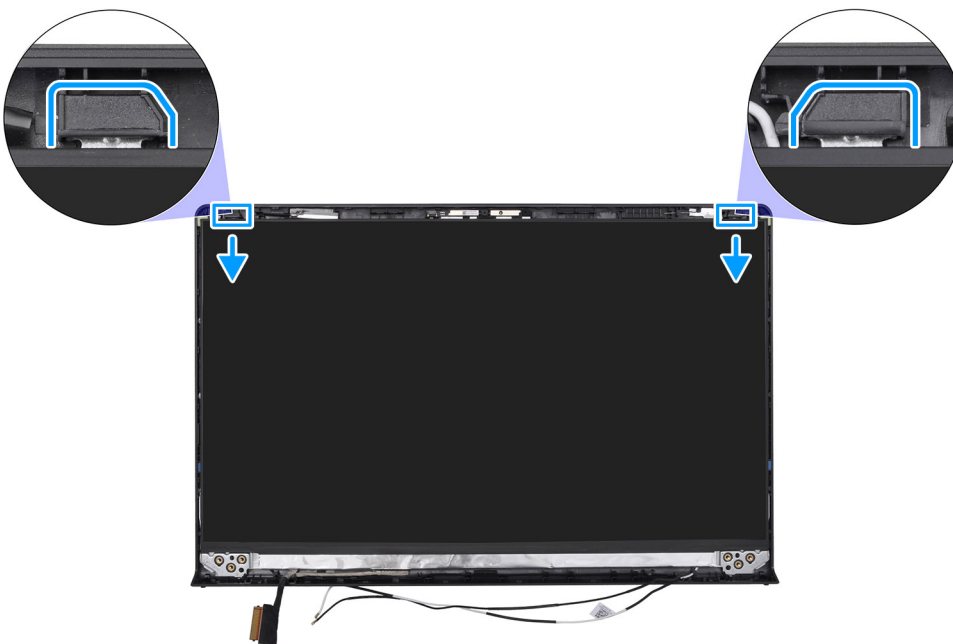

5. Gently flip the display panel assembly forward, peel back the tape that secures the display cable to the connector on the rear of the display panel.

**i** **NOTE:** Ensure that the panel has a clean and smooth surface to rest on, to prevent damage.

6. Disconnect the display cable from the connector on the display panel and remove the display panel.

**i** **NOTE:** The display panel is assembled with the display brackets as a single service part. DO NOT pull the two pieces of elastic tape and separate the brackets from the panel.



## Installing the display panel

**CAUTION:** The information in this section is intended for authorized service technicians only.

### Prerequisites

If you are replacing a component, remove the existing component before performing the installation procedure.

### About this task

**NOTE:** This procedure applies only to computers with a plastic chassis.

The following images indicate the location of the display panel and provide a visual representation of the installation procedure.

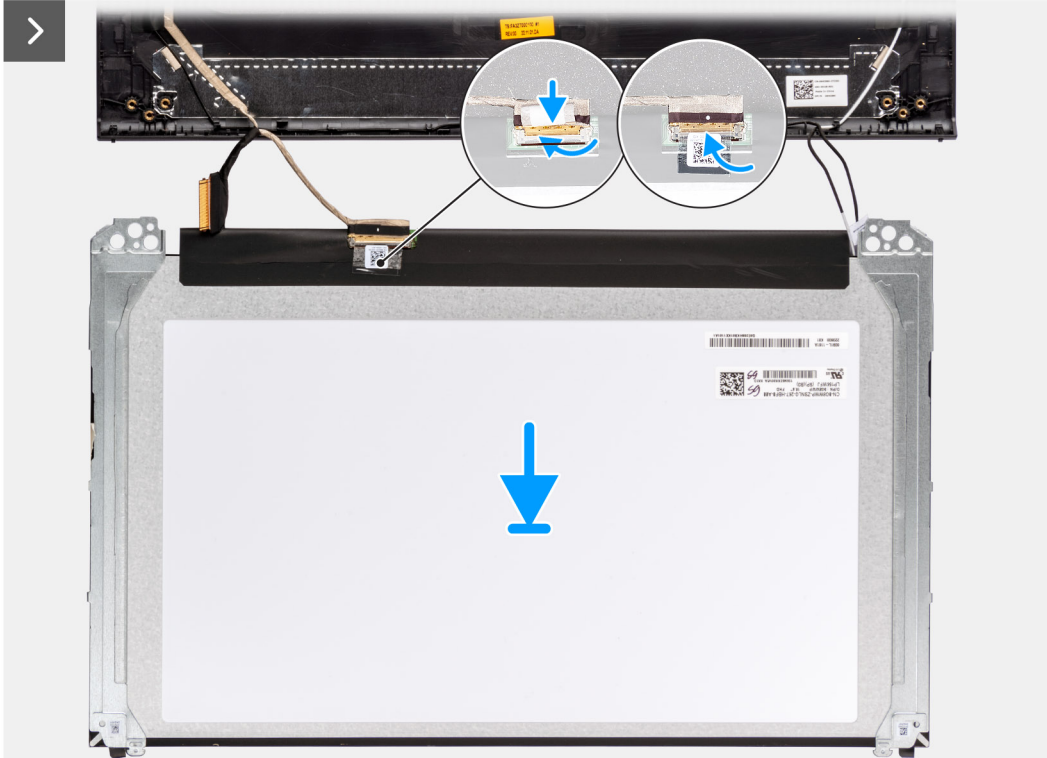



### Steps

1. Place the display panel and display assembly on a clean and flat surface.
2. Connect the display cable to the connector on the display panel and close the latch.
3. Adhere the tape to secure the display cable to the connector on the display panel.
4. Turn the display panel over and place the display panel on the display back-cover.
5. Lift the bottom side of the display panel and slide the top side into the slots at the top of the display back-cover.
6. Gently push down on the edges of the display panel until it clicks into the tabs on the display back-cover.

### Next steps

1. Install the [display hinges](#).
2. Install the [display bezel](#).
3. Install the [display hinge caps](#).
4. Install the [display assembly](#).
5. Install the [wireless card](#).
6. Install the [base cover](#).
7. Follow the procedure in [After working inside your computer](#).



# Camera

## Removing the camera

**CAUTION:** The information in this section is intended for authorized service technicians only.

### Prerequisites

1. Follow the procedure in [Before working inside your computer](#).
2. Remove the [base cover](#).
3. Remove the [wireless card](#).
4. Remove the [display assembly](#).
5. Remove the [display hinge caps](#).
6. Remove the [display bezel](#).
7. Remove the [display hinges](#).
8. Remove the [display panel](#).

### About this task

**NOTE:** This procedure applies only to computers with a plastic chassis.

The following images indicate the location of the camera module and provide a visual representation of the removal procedure.

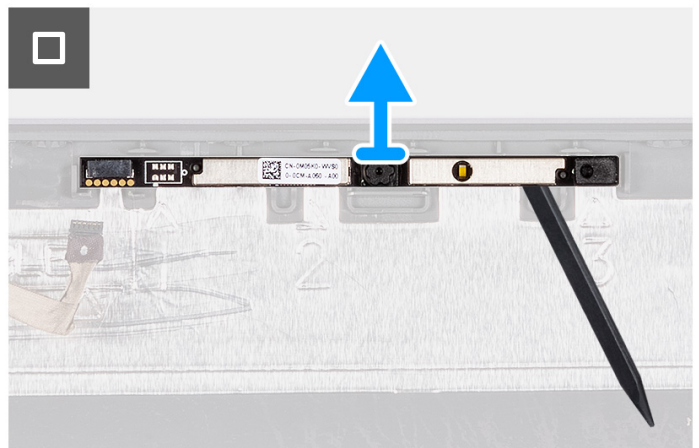
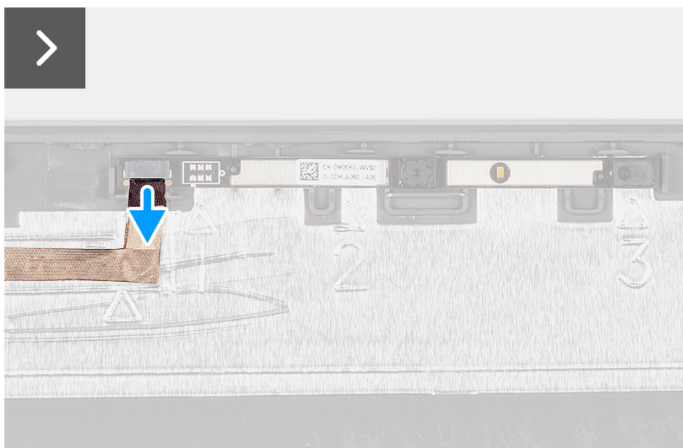
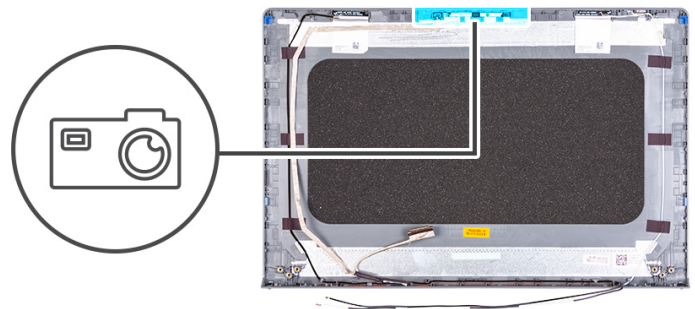

### Steps

1. Disconnect the display cable from the connector on the camera module.
2. Using a plastic scribe, gently pry the camera off the display back-cover and antenna assembly.
3. Remove the camera module from the display assembly.

## Installing the camera

**CAUTION:** The information in this section is intended for authorized service technicians only.

### Prerequisites

If you are replacing a component, remove the existing component before performing the installation procedure.

### About this task

**NOTE:** This procedure applies only to computers with a plastic chassis.

The following images indicate the location of the camera module and provide a visual representation of the installation procedure.

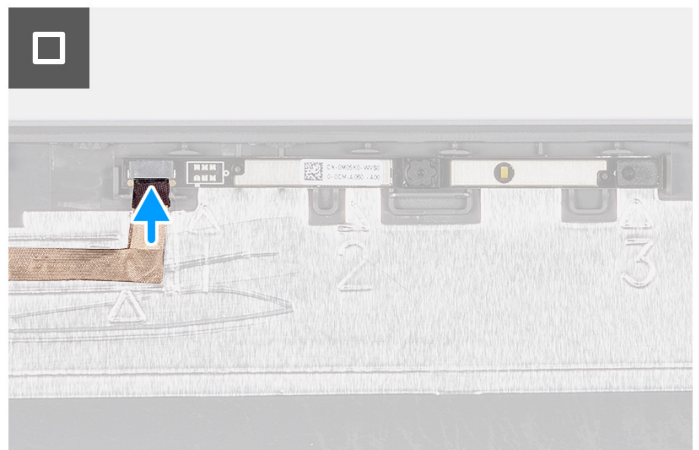
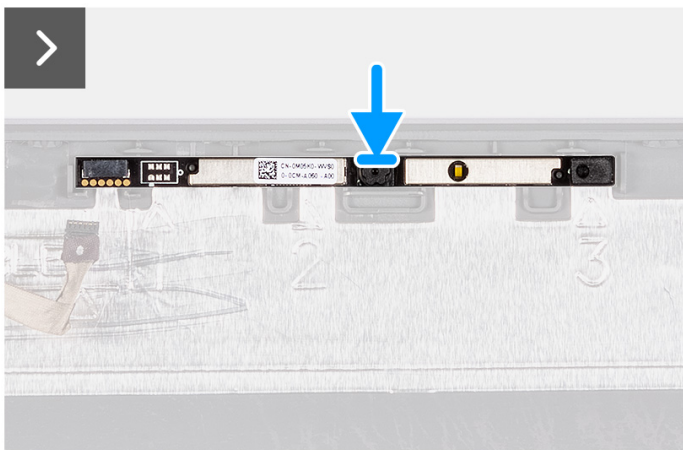
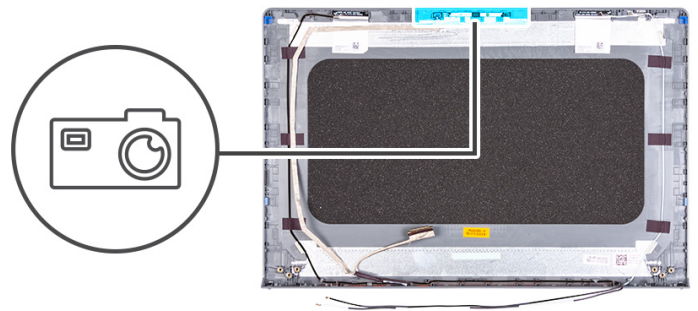

### Steps

1. Using the alignment post, adhere the camera module on the display back-cover and antenna assembly.
2. Connect the display cable to the connector on the camera module.

### Next steps

1. Install the [display panel](#).
2. Install the [display hinges](#).
3. Install the [display bezel](#).
4. Install the [display hinge caps](#).
5. Install the [display assembly](#).
6. Install the [wireless card](#).
7. Install the [base cover](#).
8. Follow the procedure in [After working inside your computer](#).

# Display cable

## Removing the display cable

 **CAUTION:** The information in this section is intended for authorized service technicians only.

### Prerequisites

1. Follow the procedure in [Before working inside your computer](#).
2. Remove the [base cover](#).
3. Remove the [wireless card](#).
4. Remove the [display assembly](#).
5. Remove the [display hinge caps](#).
6. Remove the [display bezel](#).
7. Remove the [display hinges](#).
8. Remove the [display panel](#).

### About this task

 **NOTE:** This procedure applies only to computers with a plastic chassis.

The following image indicates the location of the display cable and provides a visual representation of the removal procedure.

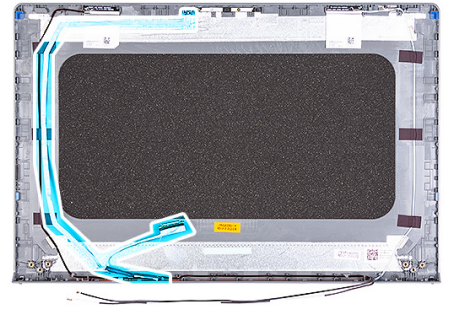

### Steps

1. Disconnect the display eDP cable from the connector on the camera module.
2. Carefully peel back and remove the display eDP cable from the display back-cover and antenna assembly.

## Installing the display cable

**CAUTION:** The information in this section is intended for authorized service technicians only.

### Prerequisites

If you are replacing a component, remove the existing component before performing the installation procedure.



## About this task

**i** **NOTE:** This procedure applies only to computers with a plastic chassis.

The following image indicates the location of the display cable and provides a visual representation of the installation procedure.

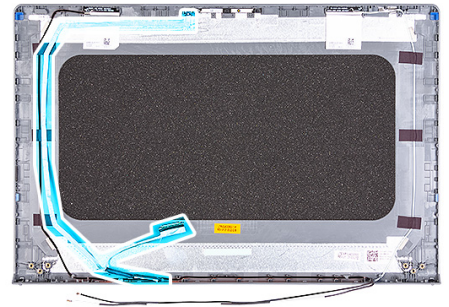

## Steps

1. Adhere the display eDP cable to the display back-cover and antenna assembly.
2. Connect the display eDP cable to the connector on the camera module.

## Next steps

1. Install the [display panel](#).
2. Install the [display hinges](#).
3. Install the [display bezel](#).
4. Install the [display hinge caps](#).

5. Install the [display assembly](#).
6. Install the [wireless card](#).
7. Install the [base cover](#).
8. Follow the procedure in [After working inside your computer](#).

## Display back-cover and antenna assembly

### Removing the display back-cover and antenna assembly

 **CAUTION:** The information in this section is intended for authorized service technicians only.

#### Prerequisites

1. Follow the procedure in [Before working inside your computer](#).
2. Remove the [base cover](#).
3. Remove the [wireless card](#).
4. Remove the [display assembly](#).
5. Remove the [display hinge caps](#).
6. Remove the [display bezel](#).
7. Remove the [display hinges](#).
8. Remove the [display panel](#).
9. Remove the [camera](#).
10. Remove the [display cable](#).

#### About this task

 **NOTE:** This procedure applies only to computers with a plastic chassis.

 **NOTE:** The display back-cover and antenna assembly cannot be further disassembled once all the pre-removal parts procedures are completed. If the wireless antennas are malfunctioning and are required to be replaced, replace the entire display back-cover and antenna assembly.

The image below shows the display back-cover and antenna assembly after the pre-removal parts procedures have been performed for any display back-cover and antenna assembly replacement.





### Steps

After performing the pre-requisites, you are left with the display back-cover and antenna assembly.

## Installing the display back-cover and antenna assembly

**CAUTION:** The information in this section is intended for authorized service technicians only.

### Prerequisites

If you are replacing a component, remove the existing component before performing the installation procedure.

### About this task

**NOTE:** This procedure applies only to computers with a plastic chassis.

The following image indicates the location of the display back-cover and antenna assembly and provides a visual representation of the installation procedure.





### Steps

Place the display back-cover and antenna assembly on a flat surface and perform the post-requisites to install the display back-cover and antenna assembly.

### Next steps

1. Install the [display cable](#).
2. Install the [camera](#).
3. Install the [display panel](#).
4. Install the [display hinges](#).
5. Install the [display bezel](#).
6. Install the [display hinge caps](#).
7. Install the [display assembly](#).
8. Install the [wireless card](#).
9. Install the [base cover](#).
10. Follow the procedure in [After working inside your computer](#).

## System board

### Removing the system board

**⚠ CAUTION:** The information in this section is intended for authorized service technicians only.

## Prerequisites

1. Follow the procedure in [Before working inside your computer](#).
2. Remove the [base cover](#).
3. Remove the [memory module](#).
4. Remove the [solid state drive](#).
5. Remove the [wireless card](#).
6. Remove the [fan](#).
7. Remove the [heat sink](#).

**NOTE:** When removing the system board to replace/access other parts, the system board can be removed with the heat sink attached to it in order to simplify the procedure and preserve the thermal bond between the system board and heat sink.

## About this task

The following image indicates the connectors on your system board.

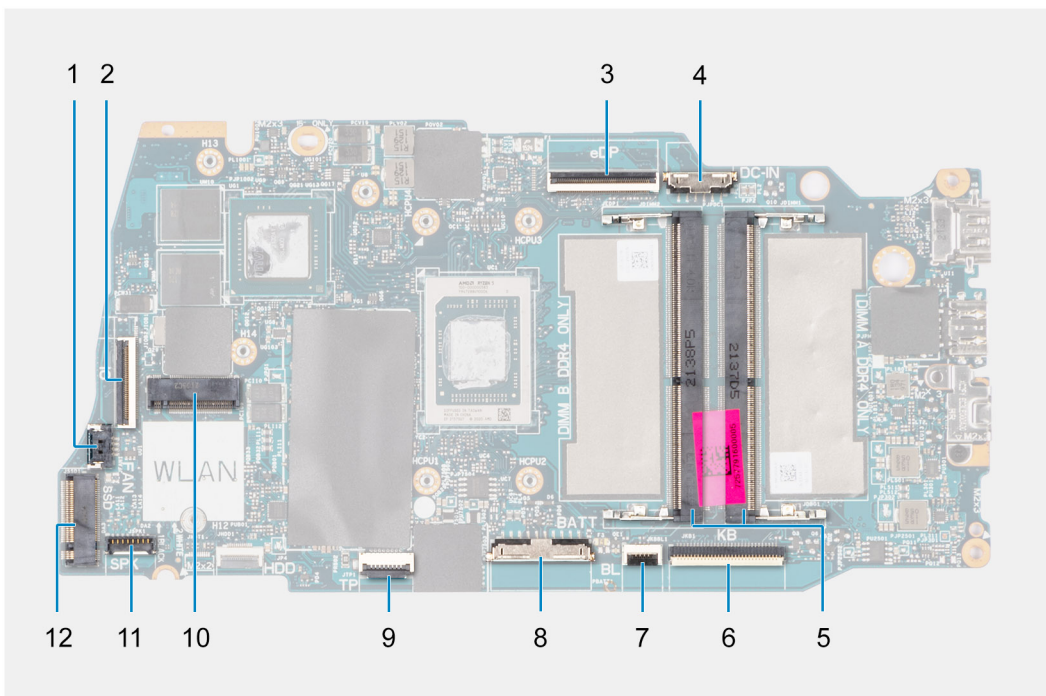

- |                                     |                                     |
|-------------------------------------|-------------------------------------|
| 1. Fan-cable connector              | 2. I/O daughter-board FFC connector |
| 3. eDP connector                    | 4. Power-adaptor port connector     |
| 5. Memory-module connector          | 6. Keyboard FFC connector           |
| 7. Keyboard-backlight FFC connector | 8. Battery connector                |
| 9. Touchpad FFC connector           | 10. Wireless-card connector         |
| 11. Speaker-cable connector         | 12. Solid state drive connector     |

The following images indicate the location of the system board and provide a visual representation of the removal procedure.



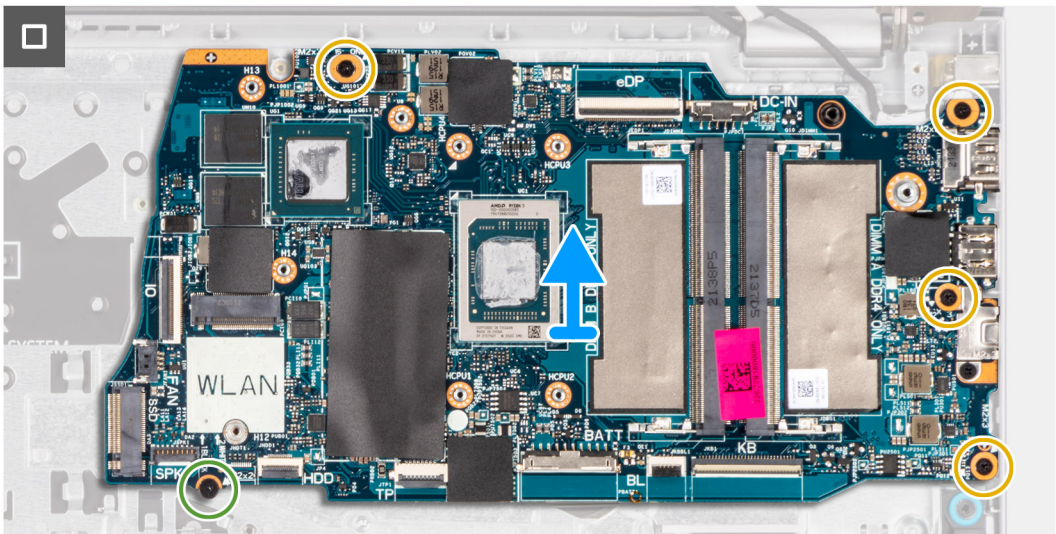
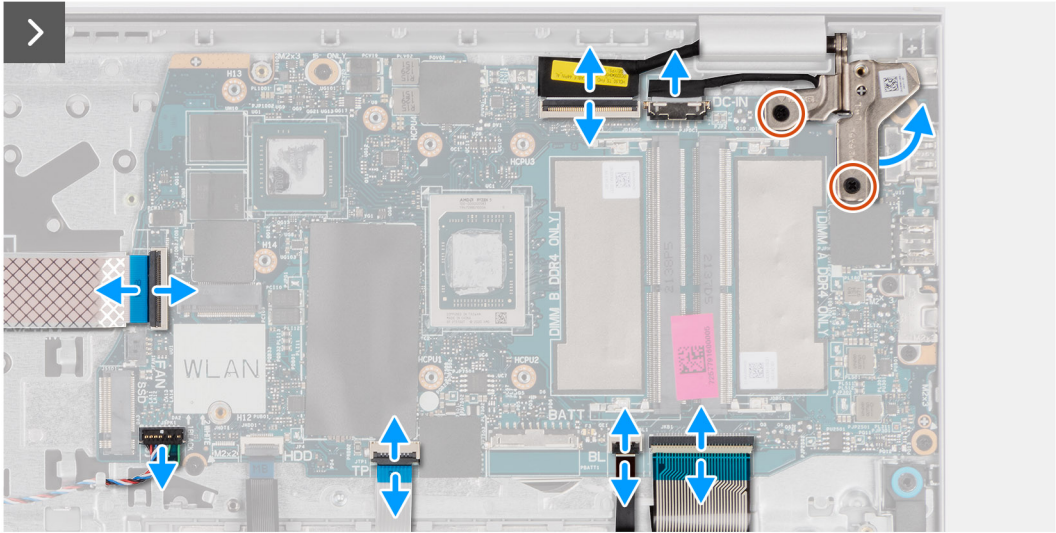
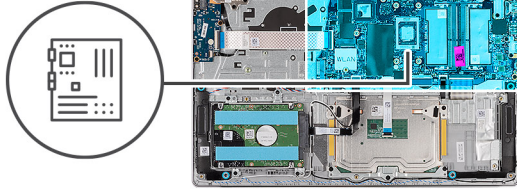

### Steps

1. Remove the two screws (M2.5x5) that secure the right display hinge to the system board and the palm-rest and keyboard assembly.
2. Using a plastic scribe, lift the right display hinge away from the palm-rest and keyboard assembly.
3. Disconnect the following cables from the system board:
  - a. I/O daughter-board FFC
  - b. eDP cable
  - c. Power-adapter port cable
  - d. Keyboard FFC
  - e. Keyboard-backlight FPC
 

**NOTE:** This step applies only to computers shipped with a keyboard backlight installed.
  - f. Battery cable

- g. Touchpad FFC
  - h. Speaker cable
4. Remove the screw (M2x2) and the four screws (M2x3.5) that secure the system board to the palm-rest and keyboard assembly.

**NOTE:** Do not remove the USB Type-C bracket from the system board for individual replacement. The system board and the USB Type-C bracket are replaced as an assembly part.

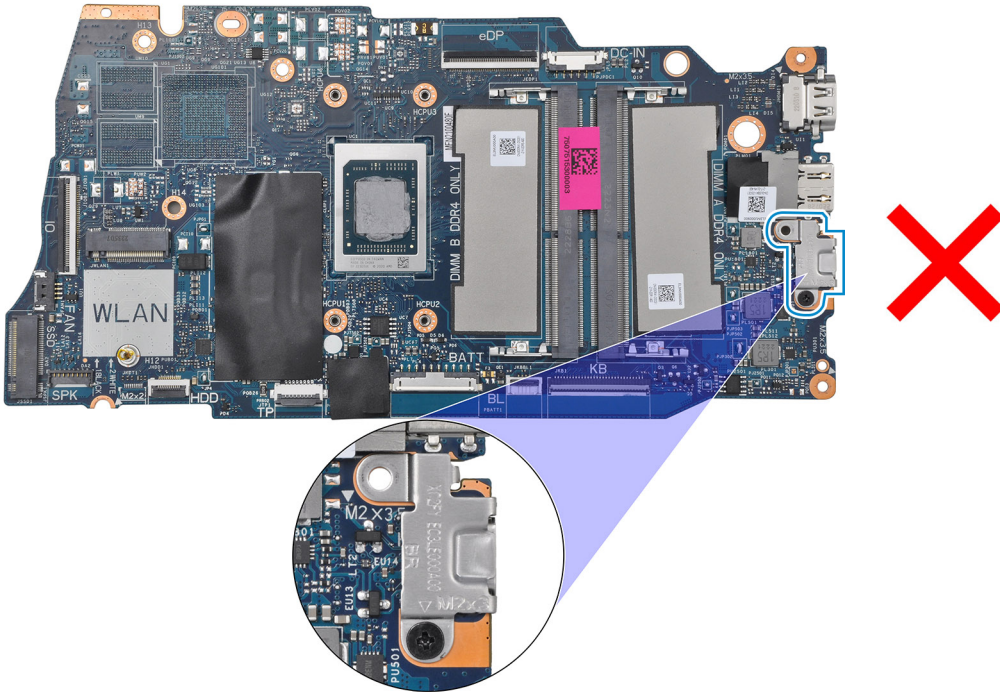

5. Carefully lift and remove the system board from the palm-rest and keyboard assembly.

## Installing the system board

**CAUTION:** The information in this section is intended for authorized service technicians only.

### Prerequisites

If you are replacing a component, remove the existing component before performing the installation procedure.

### About this task

**NOTE:** When installing the system board to replace/access other parts, the system board can be installed with the heat sink attached to it in order to simplify the procedure and preserve the thermal bond between the system board and heat sink.

The following image indicates the connectors on your system board.



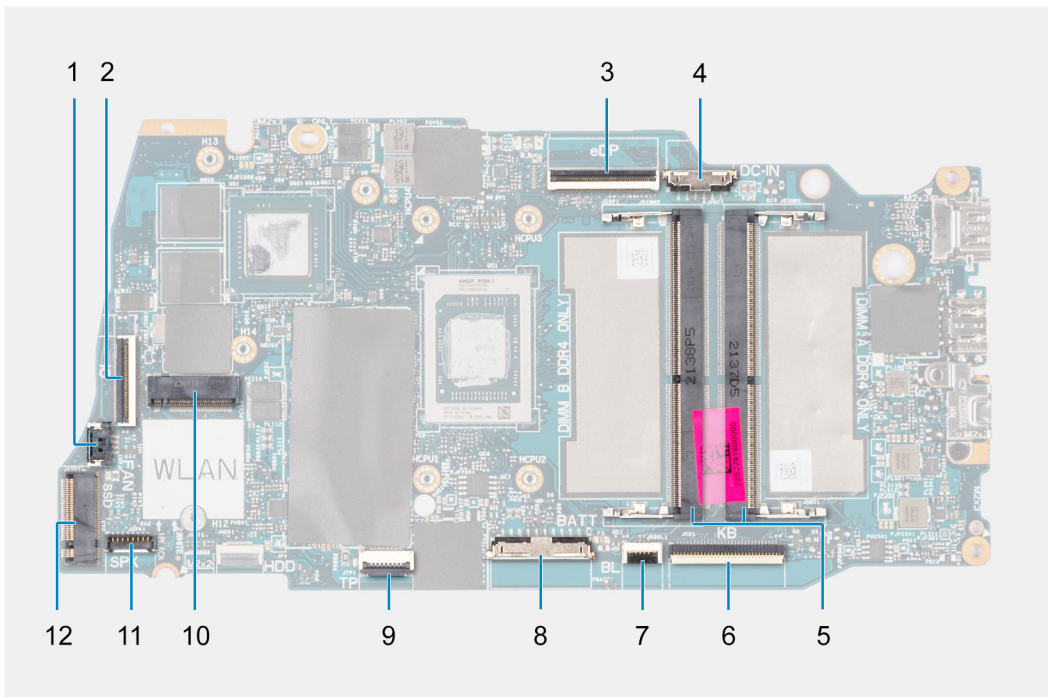

- |                                     |                                     |
|-------------------------------------|-------------------------------------|
| 1. Fan-cable connector              | 2. I/O daughter-board FFC connector |
| 3. eDP connector                    | 4. Power-adaptor port connector     |
| 5. Memory-module connector          | 6. Keyboard FFC connector           |
| 7. Keyboard-backlight FPC connector | 8. Battery connector                |
| 9. Touchpad FFC connector           | 10. Wireless-card connector         |
| 11. Speaker-cable connector         | 12. Solid state drive connector     |

The following images indicate the location of the system board and provide a visual representation of the installation procedure.

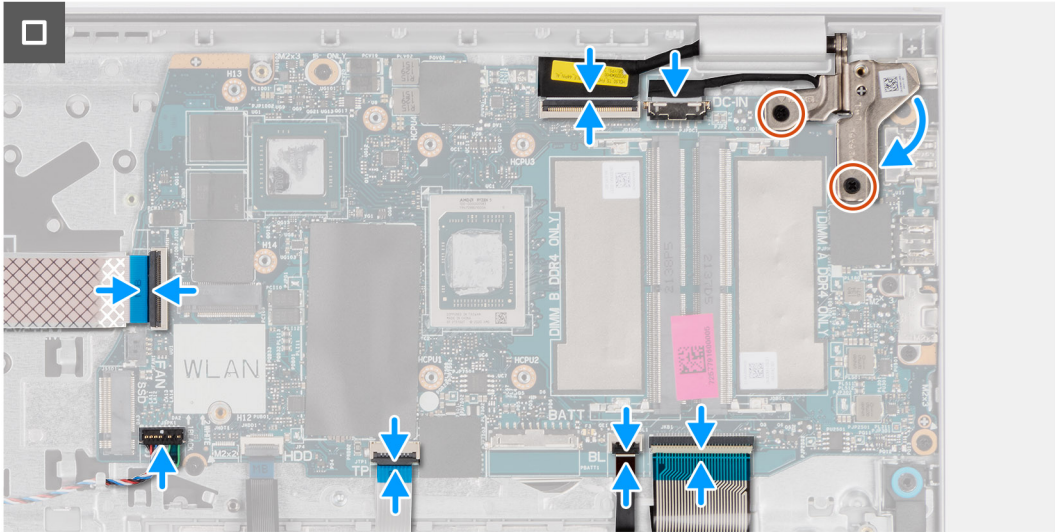
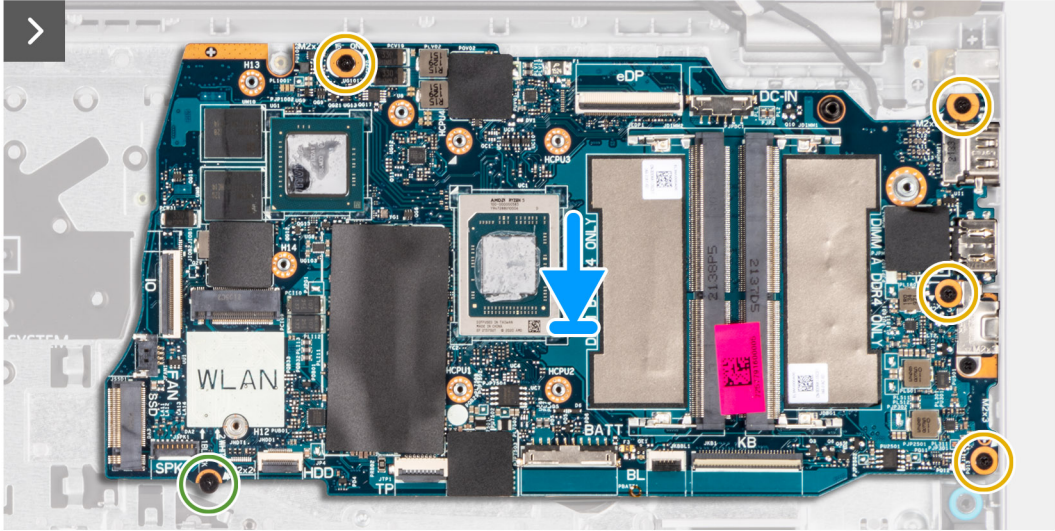
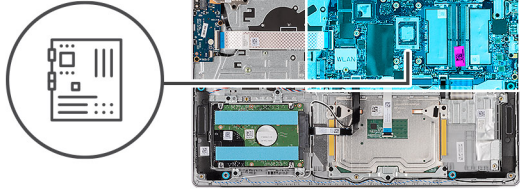

**Steps**

1. Align the ports on the system board to the port openings on the palm-rest and keyboard assembly.
2. At an angle, carefully slide and place the system board on the palm-rest and keyboard assembly.
3. Align the screw holes on the system board with the screw holes on the palm-rest and keyboard assembly.
4. Replace the screw (M2x2) and the four screws (M2x3.5) to secure the system board to the palm-rest and keyboard assembly.
5. Connect the following cables to the system board:
  - a. I/O daughter-board FFC
  - b. eDP cable
  - c. Power-adaptor port cable
  - d. Keyboard FFC
  - e. Keyboard-backlight FPC

 **NOTE:** This step applies only to computers shipped with a keyboard backlight installed.

- f. Battery cable
  - g. Touchpad FFC
  - h. Speaker cable
6. Close the right display hinge downwards to align the screw holes on the right display hinge to the screw holes on the system board and the palm-rest and keyboard assembly.
  7. Replace the two screws (M2.5x5) to secure the right display hinge to the system board and the palm-rest and keyboard assembly.

#### Next steps

1. Install the [heat sink](#).
2. Install the [fan](#).
3. Install the [wireless card](#).
4. Install the [solid state drive](#).
5. Install the [memory module](#).
6. Install the [base cover](#).
7. Follow the procedure in [After working inside your computer](#).

## Palm-rest and keyboard assembly

### Removing the palm-rest and keyboard assembly

 **CAUTION:** The information in this section is intended for authorized service technicians only.

#### Prerequisites

1. Follow the procedure in [Before working inside your computer](#).
2. Remove the [base cover](#).
3. Remove the [memory module](#).
4. Remove the [solid state drive](#).
5. Remove the [wireless card](#).
6. Remove the [speakers](#).
7. Remove the [fan](#).
8. Remove the [heat sink](#).
9. Remove the [3-cell battery](#) or the [4-cell battery](#), whichever applicable.
10. Remove the [touchpad](#).
11. Remove the [I/O daughter-board cable](#).
12. Remove the [I/O daughter-board](#).
13. Remove the [power button](#) or the [power button with optional fingerprint reader](#), whichever applicable.
14. Remove the [power-adaptor port](#).
15. Remove the [display assembly](#).
16. Remove the [system board](#).

 **NOTE:** When removing the system board to replace/access other parts, the system board can be removed with the heat sink attached to it in order to simplify the procedure and preserve the thermal bond between the system board and heat sink.

#### About this task

 **NOTE:** The palm-rest and keyboard assembly cannot be further disassembled once all the pre-removal parts procedures are completed. If the keyboard is malfunctioning and is required to be replaced, replace the entire palm-rest and keyboard assembly.



The image below shows the palm-rest and keyboard assembly after the pre-removal parts procedures have been performed for any palm-rest and keyboard assembly replacement.

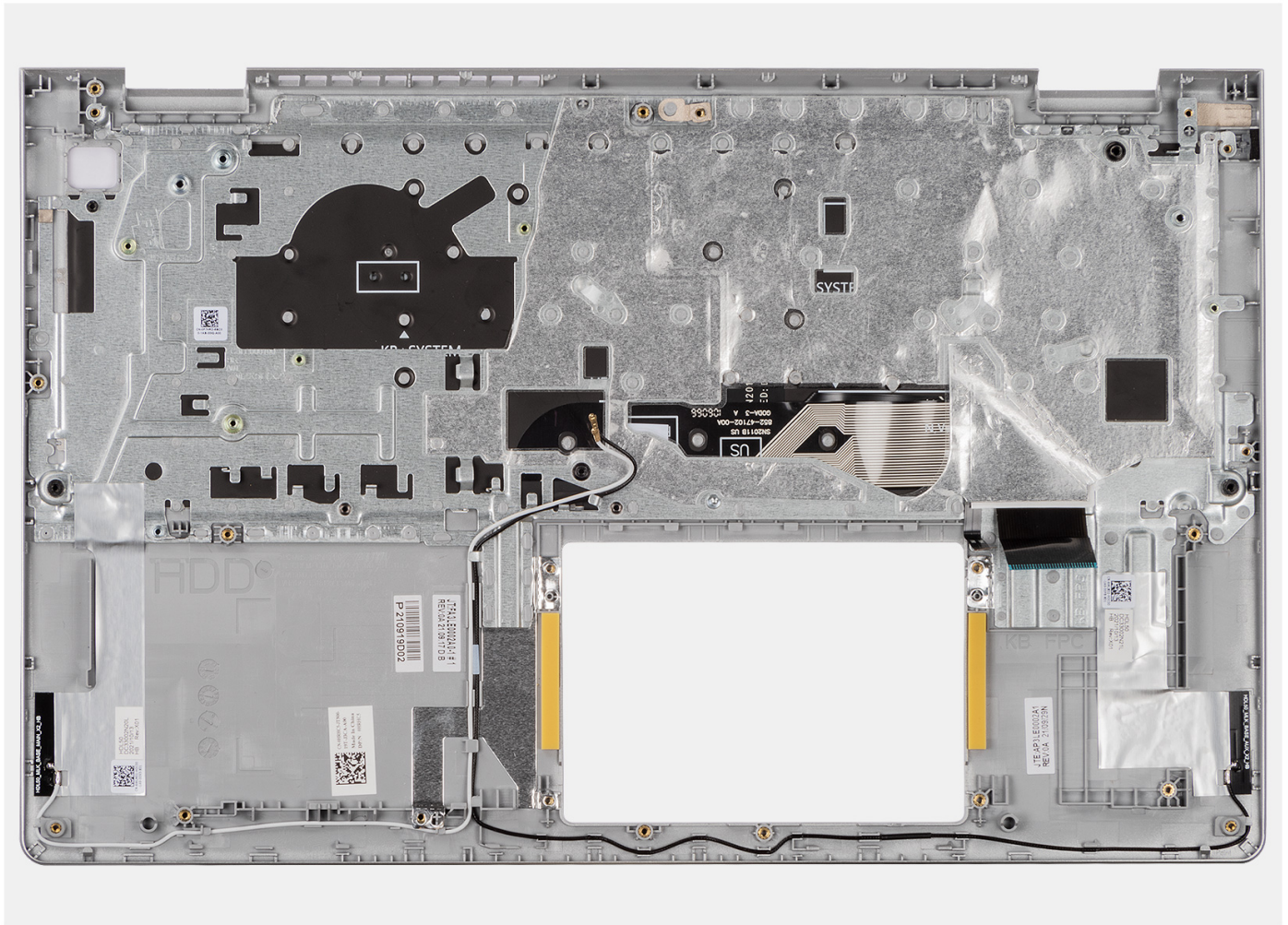

### Steps

1. For computers shipped with aluminum chassis and a 4-cell battery installed, remove the two screws (M2x2) that secure the left RF metal wall bracket to the palm-rest and keyboard assembly.

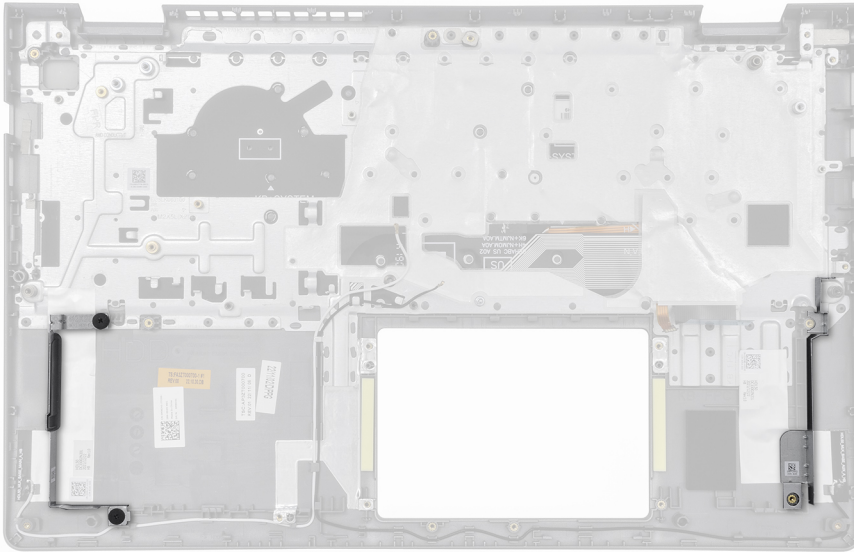

2. For computers shipped with aluminum chassis, remove the right and left RF metal wall brackets from the palm-rest and keyboard assembly.

**i** **NOTE:** The left and right RF metal wall brackets **MUST** be transferred to the replacement palm-rest and keyboard assembly.

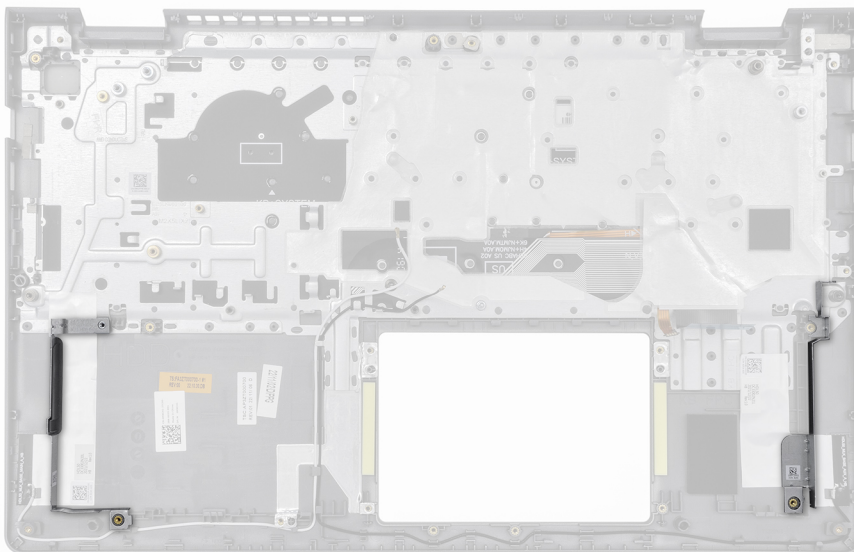

3. After performing the **Prerequisites**, you are left with the palm-rest and keyboard assembly.

## Installing the palm-rest and keyboard assembly

**⚠ CAUTION:** The information in this section is intended for authorized service technicians only.

### Prerequisites

If you are replacing a component, remove the existing component before performing the installation procedure.



## About this task

**NOTE:** The system board can be installed with the heat sink attached to it in order to simplify the procedure and preserve the thermal bond between the system board and heat sink.

The following image indicates the location of the palm-rest and keyboard assembly and provides a visual representation of the installation procedure.

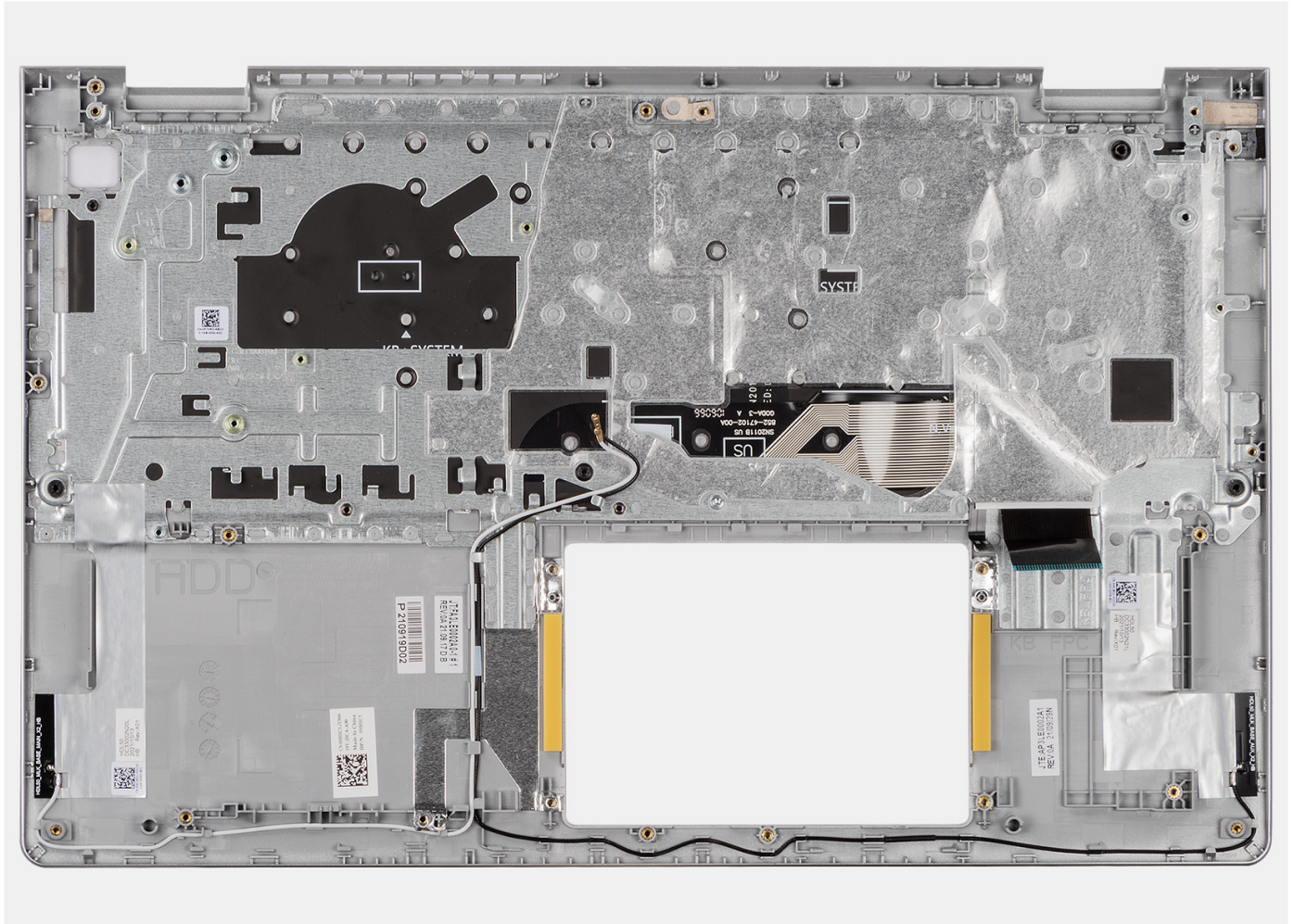

## Steps

1. Place the palm-rest and keyboard assembly on a flat surface and perform the **Next steps** to install the palm-rest and keyboard assembly.
2. For computers shipped with aluminum chassis, place the right and left RF metal wall brackets in the slot on the palm-rest and keyboard assembly.

**NOTE:** The left and right RF metal wall brackets **MUST** be transferred to the replacement palm-rest and keyboard assembly.

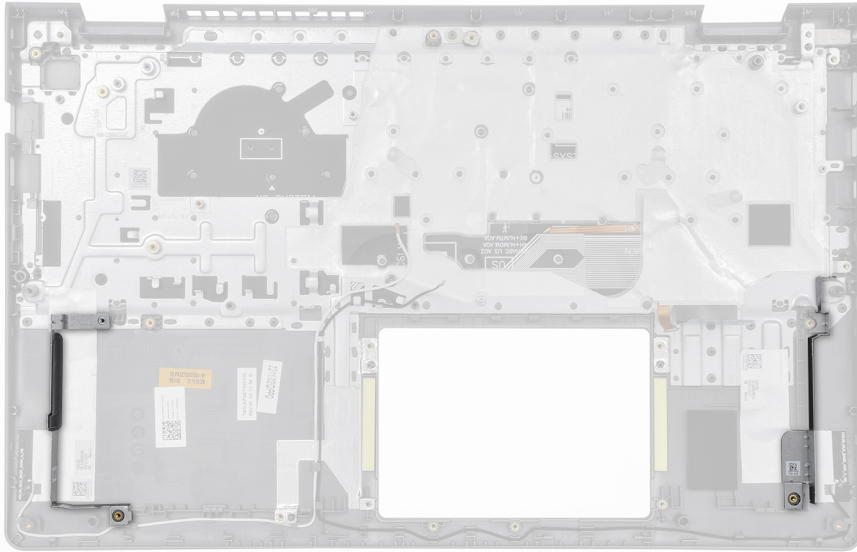

3. For computers shipped with aluminum chassis and a 4-cell battery installed, replace the two screws (M2x2) to secure the left RF metal wall bracket to the palm-rest and keyboard assembly.

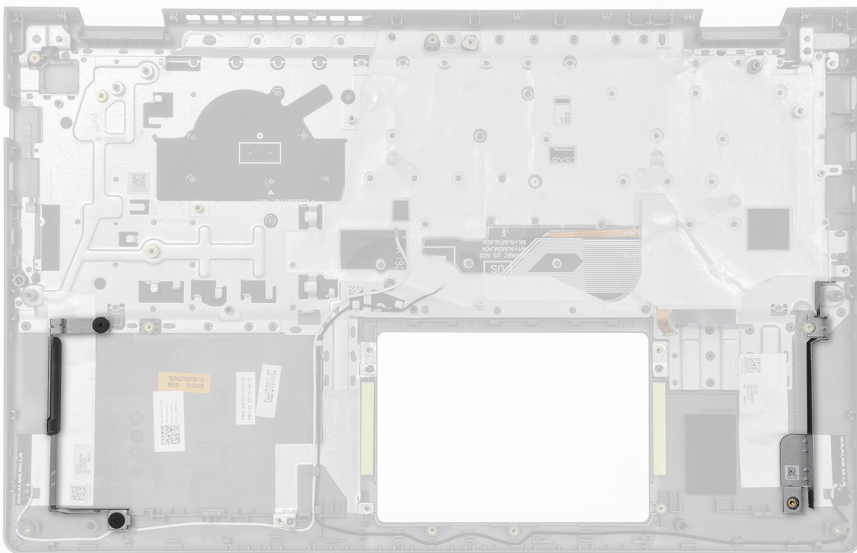

### Next steps

1. Install the [system board](#).
2. Install the [display assembly](#).
3. Install the [power-adaptor port](#).
4. Install the [power button](#) or the [power button with optional fingerprint reader](#), whichever applicable.
5. Install the [I/O daughter-board](#).
6. Install the [I/O daughter-board cable](#).
7. Install the [touchpad](#).
8. Install the [3-cell battery](#) or the [4-cell battery](#), whichever applicable.
9. Install the [heat sink](#).
10. Install the [fan](#).
11. Install the [speakers](#).
12. Install the [wireless card](#).

13. Install the [solid state drive](#).
14. Install the [memory module](#).
15. Install the [base cover](#).
16. Follow the procedure in [After working inside your computer](#).

# Software

This chapter details the supported operating systems along with instructions on how to install the drivers.

## Operating system

Your Dell Pro 15 Essential PV15250 supports the following operating systems:

- Windows 11 Pro
- Windows 11 Pro National Academic
- Windows 11 Home
- Windows 11 Home (S mode)
- Ubuntu Linux 22.04 LTS, 64-bit

## Drivers and downloads

When troubleshooting, downloading, or installing drivers, it is recommended that you read the [Dell Knowledge Base article Drivers and Downloads FAQs](#).

# BIOS Setup

**CAUTION:** Certain changes can make your computer work incorrectly. Before you change the settings in BIOS Setup, it is recommended that you note down the original settings for future reference.

**NOTE:** Depending on the computer and the installed devices, the options that are listed in this section may differ.

Use BIOS Setup for the following purposes:

- Get information about the hardware installed in your computer, such as the amount of RAM and the capacity of the storage device.
- Change the system configuration information.
- Set or change user-selectable options such as the user password, enabling or disabling base devices, and configuring hard drive settings.

## Entering BIOS Setup program

Turn on or restart your computer and press F2 immediately.

## Navigation keys

**NOTE:** For most of the BIOS Setup options, changes that you make are recorded but do not take effect until you restart the computer.

**Table 28. Navigation keys**

Keys	Navigation
Up arrow	Moves to the previous field.
Down arrow	Moves to the next field.
Enter	Selects a value in the selected field (if applicable) or follows the link in the field.
Spacebar	Expands or collapses a drop-down list, if applicable.
Tab	Moves to the next focus area.
Esc	Moves to the previous page until you view the main screen. Pressing Esc in the main screen displays a message that prompts you to save any unsaved changes and restart the computer.

## One time boot menu

To enter **one time boot menu**, turn on your computer, and then press F12 immediately.

**NOTE:** It is recommended to shutdown the computer if it is on.

The one-time boot menu displays the devices that you can boot from including the diagnostic option. The boot menu options are:

- Windows Boot Manager
- UEFI M.2 solid-state drive Boot
- UEFI HTTPs Boot



The boot sequence screen also displays the option to access the System Setup screen.

## System setup options

**NOTE:** Depending on your computer and its installed devices, the items that are listed in this section may or may not appear.

**Table 29. BIOS Setup options—Overview menu**

Overview	Description
<b>Dell Pro 15 Essential PV15250</b>	
BIOS Version	Displays the BIOS version number.
Service Tag	Displays the Service Tag of the computer.
Asset Tag	Displays the Asset Tag of the computer.
Manufacture Date	Displays the manufacture date of the computer.
Ownership Date	Displays the ownership date of the computer.
Express Service Code	Displays the Express Service Code of the computer.
Ownership Tag	Displays the Ownership Tag of the computer.
Signed Firmware Update	Displays whether the Signed Firmware Update is enabled on your computer. By default, the <b>Signed Firmware Update</b> option is enabled.
<b>Battery Information</b>	
Primary	Displays the primary battery of the computer.
Battery Level	Displays the battery level of the computer.
Battery State	Displays the battery state of the computer.
Health	Displays the battery health of the computer.
AC Adapter	Displays whether an AC adapter is connected. If connected, displays the type of AC adapter that is connected.
Battery Life Type	Displays the battery life type of the computer.
<b>Processor Information</b>	
Processor Type	Displays the processor type.
Maximum Clock Speed	Displays the maximum processor clock speed.
Minimum Clock Speed	Displays the minimum processor clock speed.
Current Clock Speed	Displays the current processor clock speed.
Core Count	Displays the number of cores on the processor.
Processor ID	Displays the processor identification code.
Processor L2 Cache	Displays the processor L2 cache size.
Processor L3 Cache	Displays the processor L3 cache size.
Microcode Version	Displays the microcode version.
Intel Hyper-Threading Capable	Displays whether the processor is Hyper-Threading (HT) capable.
64-Bit Technology	Displays whether 64-bit technology is used.
<b>Memory Information</b>	
Memory Installed	Displays the total memory installed on the computer.



**Table 29. BIOS Setup options—Overview menu (continued)**

Overview	Description
Memory Available	Displays the total memory available on the computer.
Memory Speed	Displays the memory speed.
Memory Channel Mode	Displays single or dual channel mode.
Memory Technology	Displays the technology that is used for the memory.
DIMM A Size	Displays the total DIMM A computer memory available, with memory type.
DIMM B Size	Displays the total DIMM B computer memory available, with memory type.
<b>Devices Information</b>	
Panel Type	Displays the type of display panel available on the computer.
Video Controller	Displays the type of video controller available on the computer.
Video Memory	Displays the video memory information of the computer.
Wi-Fi Device	Displays the wireless device information of the computer.
Native Resolution	Displays the native resolution of the computer.
Video BIOS Version	Displays the video BIOS version of the computer.
Audio Controller	Displays the audio controller information of the computer.
Bluetooth Device	Displays the Bluetooth device information of the computer.

**Table 30. System setup options — Boot Configuration menu**

Boot Configuration	Description
<b>Boot Sequence</b>	
Boot Mode: UEFI only	Displays the boot mode of the computer.
Boot Sequence	<p>Specifies the order that the BIOS searches the list of devices to find an operating system to boot.</p> <p>By default, the <b>Windows Boot Manager</b> option is selected.</p> <p>By default, the <b>UEFI RST CL4-3D512-Q11 NVMe SSSTC 512GB VFN39DH0027807S8</b> option is selected.</p> <p>By default, the <b>UEFI HTTPs Boot</b> option is selected.</p>
Enable PXE Boot Priority	<p>When enabled, any new PXE boot option that is detected by the computer is added to the top of the Boot Sequence.</p> <p>By default, the <b>Enable PXE Boot Priority</b> option is disabled.</p>
<b>Secure Boot</b>	
Enable Secure Boot	<p>Secure Boot is a method of guaranteeing the integrity of the boot path by performing additional validation of the operating system and PCI add-in cards. The computer stops booting to the operating system when a component is not authenticated during the boot process. Secure Boot can be enabled in BIOS setup or using management interfaces, but can only be disabled from BIOS setup.</p> <p>Enables the computer to boot using only validated boot software.</p> <p>By default, the <b>Enable Secure Boot</b> option is enabled.</p> <p>For additional security, Dell Technologies recommends keeping the <b>Secure Boot</b> option enabled to ensure that the UEFI firmware validates the operating system during the boot process.</p> <p><b>i</b> <b>NOTE:</b> For Secure Boot to be enabled, the computer is required to be in UEFI boot mode and the Enable Legacy Option ROMs option is required to be turned off.</p>

**Table 30. System setup options — Boot Configuration menu (continued)**

Boot Configuration	Description
Enable Microsoft UEFI CA	<p>When disabled, the UEFI CA is removed from the BIOS UEFI Secure Boot database.</p> <p> <b>CAUTION:</b> When disabled, the Microsoft UEFI CA can cause your system to not boot, computer graphics and some devices may not function properly, and the computer could become unrecoverable.</p> <p>By default, the <b>Enable Microsoft UEFI CA</b> option is enabled.</p> <p>Microsoft HLK requirements for DeviceGuard requires the UEFI 3<sup>rd</sup> Party CA removal from the UEFI SecureBoot database (db).</p> <p>Setting this option to Hybrid mode will allow the UEFI 3<sup>rd</sup> party CA to be used to validate pre-boot option ROMs, but will not allow a bootloader signed with the UEFI 3<sup>rd</sup> party CA to be loaded.</p> <p>For additional security, Dell Technologies recommends keeping the <b>Enable Microsoft UEFI CA</b> option enabled to ensure the broadest compatibility with devices and operating systems.</p>
Secure Boot Mode	<p>Enables or disables the Secure Boot operation mode.</p> <p>By default, the <b>Deployed Mode</b> is selected.</p> <p> <b>NOTE:</b> <b>Deployed Mode</b> should be selected for normal operation of Secure Boot.</p>
<b>Expert Key Management</b>	
Enable Custom Mode	<p>Enables or disables the ability to modify the keys in the PK, KEK, db, and dbx security key databases to be modified.</p> <p>By default, the <b>Enable Custom Mode</b> option is disabled.</p>
Custom Mode Key Management	<p>Selects the custom values for expert key management.</p> <p>By default, the <b>PK</b> option is selected.</p>

**Table 31. System setup options — Integrated Devices menu**

Integrated Devices	Description
<b>Date/Time</b>	
Date	Sets the computer date in MM/DD/YYYY format. Changes to the date format take effect immediately.
Time	Sets the computer time in HH/MM/SS 24-hour format. You can switch between a 12-hour and 24-hour clock. Changes to the time format take effect immediately.
<b>Camera</b>	
Enable Camera	<p>Enables the camera.</p> <p>By default, the <b>Enable Camera</b> option is enabled.</p> <p> <b>NOTE:</b> Depending on the configuration ordered, the camera setup option may not be available.</p>
<b>Audio</b>	
Enable Microphone	<p>Enables the microphone.</p> <p>By default, the <b>Enable Microphone</b> option is enabled.</p>

**Table 31. System setup options — Integrated Devices menu (continued)**

Integrated Devices	Description
	 <b>NOTE:</b> Depending on the configuration ordered, the microphone setup option may not be available.
Enable Internal Speaker	Enables the internal speaker. By default, the <b>Enable Internal Speaker</b> option is enabled.
<b>USB Configuration</b>	
Enable USB Boot Support	Enables booting from USB mass storage devices that are connected to external USB ports.  When enabled, bootable USB mass storage devices (such as HDD, flash drive, CD/DVD) can boot through the boot sequence or boot menu. USB ports are also functional in an OS environment.  When disabled, bootable USB mass storage devices are prevented from booting through the boot sequence or boot menu but the USB ports are functional in an OS environment.  By default, the <b>Enable USB Boot Support</b> option is enabled.



**Table 32. System setup options — Storage menu**

Storage	Description
<b>SATA/NVMe Operation</b>	Sets the operating mode of the integrated SATA hard drive controller. By default, the <b>RAID On</b> option is selected.
<b>Storage interface</b>	Displays the information of various onboard drives.
Port Enablement	Enables or disables the onboard drives. By default, the <b>M.2 PCIe SSD</b> option is enabled.
<b>Drive Information</b>	
<b>M.2 PCIe SSD</b>	
Type	Displays the M.2 PCIe SSD type information of the computer.
Device	Displays the M.2 PCIe SSD device information of the computer.

**Table 33. System setup options — Display menu**

Display	Description
<b>Display Brightness</b>	
Brightness on battery power	Enables to set the screen brightness when the computer is running on battery power. By default, the <b>Brightness on battery power</b> level is set to 50.
Brightness on AC power	Enables to set the screen brightness when the computer is running on AC power. By default, the <b>Brightness on AC power</b> level is set to 100.
<b>EcoPower</b>	
Enable EcoPower	Enables or disables the EcoPower feature.  When enabled, EcoPower helps increase the battery life by reducing the display brightness when appropriate.  By default, the <b>Enable EcoPower</b> option is enabled.

**Table 34. System setup options — Security menu**

Security	Description
<b>Intel Platform Trust Technology (PTT)</b>	<p>Intel PTT is a firmware-based Trusted Platform Module (fTPM) device that is part of Intel chipsets. It provides credential storage and key management that can replace the equivalent functionality of a discrete TPM chip.</p> <p> <b>NOTE:</b> The options that are listed apply to computers without a discrete <b>Trusted Platform Module (TPM)</b>.</p>
Physical Presence Interface (PPI) Bypass for Clear Commands	<p>The PPI Bypass for Clear Commands option allows the operating system to manage certain aspects of PTT. When enabled, you are not prompted to confirm changes to the PTT configuration.</p> <p>By default, the <b>PPI Bypass for Clear Commands</b> option is disabled.</p> <p>For additional security, Dell Technologies recommends keeping the <b>PPI Bypass for Clear Commands</b> option disabled.</p>
Clear	<p>When enabled, the <b>Clear</b> option clears the information that is stored in the PTT fTPM after exiting the BIOS setup of your computer. This option returns to the disabled state when the computer restarts.</p> <p>By default, the <b>Clear</b> option is disabled.</p> <p>Dell Technologies recommends enabling the <b>Clear</b> option only when PTT fTPM data needs to be cleared.</p>
Legacy Manageability Interface Access	Allows access to the Legacy Manageability Interface.
<b>Data Wipe on Next Boot</b>	
Start Data Wipe	<p>Data Wipe is a secure wipe operation that deletes information from a storage device.</p> <p> <b>CAUTION: The secure Data Wipe operation deletes information in a way that it cannot be reconstructed.</b></p> <p>Commands such as delete and format in the operating system may remove files from showing up in the file system. However, they can be reconstructed through forensic means as they are still represented on the physical media. Data Wipe prevents this reconstruction and the data can no longer be recovered.</p> <p>When enabled, the data wipe option provides prompts to wipe any storage devices that are connected to the computer on the next boot.</p> <p>By default, the <b>Start Data Wipe</b> option is disabled.</p>

**Table 35. System setup options — Passwords menu**

Passwords	Description
<b>Administrator Password</b>	<p>The Administrator Password prevents unauthorized access to the BIOS Setup options. Once the administrator password is set, the BIOS setup options can only be modified after providing the correct password.</p> <p>The following rules and dependencies apply to the Administrator Password -</p> <ul style="list-style-type: none"> <li>• The administrator password cannot be set if computer and/or internal storage passwords are previously set.</li> <li>• The administrator password can be used in place of the computer and/or internal storage passwords.</li> <li>• When set, the administrator password must be provided during a firmware update.</li> <li>• Clearing the administrator password also clears the computer password (if set).</li> </ul> <p>Dell Technologies recommends using an administrator password to prevent unauthorized changes to BIOS setup options.</p>



**Table 35. System setup options — Passwords menu (continued)**

Passwords	Description
<b>System Password</b>	<p>The System Password prevents the computer from booting to an operating system without entering the correct password.</p> <p>The following rules and dependencies apply when the System Password is used -</p> <ul style="list-style-type: none"> <li>• The computer shuts down when idle for approximately 10 minutes at the computer password prompt.</li> <li>• The computer shuts down after three incorrect attempts to enter the computer password.</li> <li>• The computer shuts down when the <b>Esc</b> key is pressed at the System Password prompt.</li> <li>• The computer password is not prompted when the computer resumes from standby mode.</li> </ul> <p>Dell Technologies recommends using the computer password in situations where it is likely that a computer may be lost or stolen.</p>
<b>M.2 PCIe SSD-0</b>	Enables the user to set, change, or delete the M.2 PCIe SSD-0 password.

**Table 36. System setup options — Update, Recovery menu**

Update, Recovery	Description
<b>SupportAssist OS Recovery</b>	<p>Enables or disables the boot flow for SupportAssist OS Recovery tool in the event of certain computer errors.</p> <p>By default, the <b>SupportAssist OS Recovery</b> option is enabled.</p>
<b>BIOSConnect</b>	<p>Enables or disables cloud Service operating system recovery if the main operating system fails to boot with the number of failures equal to or greater than the value specified by the Auto OS Recovery Threshold setup option and local Service operating system does not boot or is not installed.</p> <p>By default, the <b>BIOSConnect</b> option is enabled.</p>
<b>Dell Auto OS Recovery Threshold</b>	<p>Allows you to control the automatic boot flow for SupportAssist System Resolution Console and for Dell OS Recovery Tool.</p> <p>By default, the <b>Dell Auto OS Recovery Threshold</b> value is set to 2.</p>

**Table 37. System setup options — System Management menu**

System Management	Description
<b>Service Tag</b>	Displays the Service Tag of the computer.
<b>Asset Tag</b>	<p>Creates a computer Asset Tag that can be used by an IT administrator to uniquely identify a particular computer.</p> <p> <b>NOTE:</b> Once set in BIOS, the Asset Tag cannot be changed.</p>
<b>Diagnostics</b>	
OS Agent Requests	<p>Enables or disables the Dell OS Agent to schedule onboard diagnostics on a subsequent boot. Enabling this option helps assist in prevention and resolution of hardware related issues.</p> <p>By default, the <b>OS Agent Requests</b> option is enabled.</p>

**Table 38. System setup options — Keyboard menu**

Keyboard	Description
<b>Keyboard illumination</b>	<p>Configures the operating mode of the keyboard illumination feature.</p> <p>By default, the <b>Bright</b> option is selected. Enables the keyboard illumination feature at 100% brightness level.</p>

**Table 38. System setup options — Keyboard menu (continued)**

Keyboard	Description
<b>Keyboard Backlight Timeout on AC</b>	Sets the timeout value for the keyboard backlight when an AC adapter is connected to the computer. By default, the <b>1 minute</b> option is selected.
<b>Keyboard Backlight Timeout on battery</b>	Sets the timeout value for the keyboard backlight when the computer is running only on the battery power. The keyboard backlight timeout value is only effective when the backlight is enabled. By default, the <b>1 minute</b> option is selected.

**Table 39. System setup options — Pre-boot Behavior menu**

Pre-boot Behavior	Description
<b>Adapter Warnings</b>	
Enable Adapter Warnings	Enables or disables the computer to display adapter warning messages when adapters with too little power capacity are detected. By default, the option is enabled.
<b>Warning and Errors</b>	Enables or disables the action to be taken when a warning or error is encountered. By default, the <b>Prompt on Warnings and Errors</b> option is selected.  <b>NOTE:</b> Errors deemed critical to the operation of the computer hardware stop the functioning of the computer.

**Table 40. System setup options — System Logs menu**

System Logs	Description
<b>BIOS Event Log</b>	
Clear Bios Event Log	Allows you to select option to keep or clear BIOS events logs. By default, the <b>Keep Log</b> option is selected.
<b>Thermal Event Log</b>	
Clear Thermal Event Log	Allows you to select option to keep or clear thermal events logs. By default, the <b>Keep Log</b> option is selected.
<b>Power Event Log</b>	
Clear Power Event Log	Allows you to select option to keep or clear power events logs. By default, the <b>Keep Log</b> option is selected.

## Updating the BIOS

### Updating the BIOS in Windows

#### About this task

 **CAUTION:** If BitLocker is not suspended before updating the BIOS, the BitLocker key is not recognized the next time you reboot the computer. You will then be prompted to enter the recovery key to proceed, and the computer displays a prompt for the recovery key on each reboot. Failure to provide the recovery key can result in data loss or an operating system reinstall. For more information, see the Knowledge Base Resource [Updating the BIOS on Dell systems with BitLocker enabled](#).

 **CAUTION:** Do not turn off the computer during the BIOS flash update process. The computer may not boot if you turn off your computer.

### Steps

1. Go to [Dell Support Site](#).
2. Go to **Identify your product or ask support**. In the box, enter the product identifier, model, service request or describe what you are looking for, and then click **Search**.

 **NOTE:** If you do not have the Service Tag, click **Detect This PC**. The site automatically detects your device, and you can then click **Explore Product Support** to go to the support page for your device. You can also use the product ID or manually browse for your computer model.

3. Click **Drivers & Downloads**.
4. Select the operating system installed on your computer.
5. In the **Category** drop-down list, select **BIOS**.
6. Select the latest version of BIOS, and click **Download** to download the BIOS file for your computer.
7. After the download is complete, navigate to the folder where the BIOS update file has been saved.
8. Double-click the BIOS update file and follow the on-screen instructions.

For more information, search in the Knowledge Base Resource at [Dell Support Site](#).

## Updating the BIOS using the USB drive in Windows

### About this task

 **CAUTION:** If BitLocker is not suspended before updating the BIOS, the BitLocker key is not recognized the next time you reboot the computer. You will then be prompted to enter the recovery key to proceed, and the computer displays a prompt for the recovery key on each reboot. Failure to provide the recovery key can result in data loss or an operating system reinstall. For more information, see the Knowledge Base Resource [Updating the BIOS on Dell systems with BitLocker enabled](#).

 **CAUTION:** Do not turn off the computer during the BIOS flash update process. The computer may not boot if you turn off your computer.

### Steps

1. Go to [Dell Support Site](#).
2. Go to **Identify your product or ask support**. In the box, enter the product identifier, model, service request or describe what you are looking for, and then click **Search**.

 **NOTE:** If you do not have the Service Tag, click **Detect This PC**. The site automatically detects your device, and you can then click **Explore Product Support** to go to the support page for your device. You can also use the product ID or manually browse for your computer model.

3. Click **Drivers & Downloads**.
4. Select the operating system installed on your computer.
5. In the **Category** drop-down list, select **BIOS**.
6. Select the latest version of BIOS, and click **Download** to download the BIOS file for your computer.
7. Create a bootable USB drive. For more information, search the Knowledge Base Resource at [Dell Support Site](#).
8. Copy the BIOS Setup program file to the bootable USB drive.
9. Connect the bootable USB drive to the computer that needs the BIOS update.
10. Restart the computer and press **F12**.
11. Select the USB drive from the **One Time Boot Menu**.
12. Type the BIOS Setup program filename and press **Enter**.  
The **BIOS Update Utility** appears.
13. Follow the on-screen instructions to complete the BIOS update.

## Updating the BIOS in Linux and Ubuntu

To update the system BIOS on a computer that is installed with Linux or Ubuntu, see [How to Update the Dell BIOS in the Ubuntu or Linux Environment](#) at [Dell Support Site](#).

## Updating the BIOS from the One-Time boot menu

To update the BIOS from the One-Time boot menu, see Knowledge base article [000128928](#) at [Dell Support Site](#).

## System and setup password

 **CAUTION:** The password features provide a basic level of security for the data on your computer.

 **CAUTION:** Ensure that your computer is locked when it is not in use. Anyone can access the data that is stored on your computer, when left unattended.

**Table 41. System and setup password**

Password type	Description
System password	Password that you must enter to boot to your operating system.
Setup password	Password that you must enter to access and change the BIOS settings of your computer.

You can create a system password and a setup password to secure your computer.

 **NOTE:** The System and setup password feature is disabled by default.

## Assigning a System Setup password

### Prerequisites

You can assign a new System or Admin Password only when the status is set to **Not Set**. To enter BIOS System Setup, press F2 immediately after a power-on or reboot.

### Steps

1. To enter the **System Setup**, press **F2** immediately after a power-on or reboot.
2. In the **System BIOS** or **System Setup** screen, select **Passwords** and press Enter. The **Passwords** screen is displayed.
3. Select **System/Admin Password** and create a password in the **Enter the new password** field. Use the following guidelines to create the system password:
  - Password can be up to 32 characters.
  - Password must contain at least one special character: "( ! " # \$ % & ' \* + , - . / : ; < = > ? @ [ \ ] ^ \_ ` { | } )"
  - The password can contain numbers from 0 to 9.
  - The password can contain alphabets A to Z and a to z.
4. Type the system password that you entered earlier in the **Confirm new password** field and click **OK**.
5. Press Y to save the changes. The computer restarts.

# Deleting or changing an existing system password or setup password

## Prerequisites

Ensure that the **Password Status** is Unlocked in the System Setup before attempting to delete or change the existing system password and/or setup password. You cannot delete or change an existing system password or setup password if the **Password Status** is Locked. To enter the System Setup, press F2 immediately after a power-on or reboot.

## Steps

1. To enter the **System Setup**, press **F2** immediately after a power-on or reboot.
2. In the **System BIOS** or **System Setup** screen, select **Passwords** and press Enter. The **Passwords** screen is displayed.
3. In the **Passwords** page, verify that the **Enter the old password:** field appears inactive.
4. Select **Enter the new password:**, and update or delete the existing system password, and press Enter or Tab.
5. Select **Setup Password**. Update or delete the existing setup password, and press Enter or Tab.  
 **NOTE:** If you change the system password and/or setup password, reenter the new password when prompted. If you delete the system password and/or setup password, confirm the deletion when prompted.
6. Press **Esc**. A message prompts you to save the changes.
7. Press **Yes** to save the changes and exit from **System Setup**. The computer restarts.

# Clearing system and setup passwords

## About this task

To clear the system or setup passwords, contact Dell technical support as described at [Contact Support](#).

-  **NOTE:** For information about how to reset Windows or application passwords, see the documentation accompanying Windows or your application.



# Troubleshooting

## Handling swollen rechargeable Li-ion batteries

Like most laptops, Dell laptops use Lithium-ion batteries. One type of Lithium-ion battery is the rechargeable Li-ion battery. Rechargeable Li-ion batteries have increased in popularity in recent years and have become a standard in the electronics industry due to customer preferences for a slim form factor (especially with newer ultra-thin laptops) and long battery life. Inherent to rechargeable Li-ion battery technology is the potential for swelling of the battery cells.

A swollen battery may impact the performance of the laptop. To prevent possible further damage to the device enclosure or internal components leading to malfunction, discontinue the use of the laptop and discharge it by disconnecting the AC adapter and letting the battery drain.

Swollen batteries should not be used and must be replaced and disposed of properly. We recommend contacting Dell Support for options to replace a swollen battery under the terms of the applicable warranty or service contract, including options for replacement by a Dell authorized service technician.

The guidelines for handling and replacing rechargeable Li-ion batteries are as follows:

- Exercise caution when handling rechargeable Li-ion batteries.
- Discharge the battery before removing it from the laptop. To discharge the battery, unplug the AC adapter from the computer and operate the computer only on battery power. The battery is fully discharged when the computer no longer turns on when the power button is pressed.
- Do not crush, drop, mutilate, or penetrate the battery with foreign objects.
- Do not expose the battery to high temperatures, or disassemble battery packs and cells.
- Do not apply pressure to the surface of the battery.
- Do not bend the battery.
- Do not use tools of any type to pry on or against the battery.
- If a battery gets stuck in a device as a result of swelling, do not try to free it as puncturing, bending, or crushing a battery can be dangerous.
- Do not attempt to reassemble a damaged or swollen battery into a laptop.
- Swollen batteries that are covered under warranty should be returned to Dell in an approved shipping container (provided by Dell)—this is to comply with transportation regulations. Swollen batteries that are not covered under warranty should be disposed of at an approved recycling center. Contact Dell Support at [Dell Support Site](#) for assistance and further instructions.
- Using a non-Dell or incompatible battery may increase the risk of fire or explosion. Replace the battery only with a compatible battery purchased from Dell that is designed to work with your Dell computer. Do not use a battery from other computers with your computer. Always purchase genuine batteries from [Dell Site](#) or otherwise directly from Dell.

Rechargeable Li-ion batteries can swell for various reasons such as age, number of charge cycles, or exposure to high heat. For more information about how to improve the performance and lifespan of the laptop battery and to minimize the possibility of occurrence of the issue, search Dell laptop battery at [Dell Support Site](#).

## Dell SupportAssist Pre-boot System Performance Check diagnostics

### About this task

SupportAssist diagnostics (also known as system diagnostics) performs a complete check of your hardware. The Dell SupportAssist Pre-boot System Performance Check diagnostics is embedded with the BIOS and is launched by the BIOS internally. The embedded system diagnostics provides a set of options for particular devices or device groups allowing you to:

- Run tests automatically or in an interactive mode
- Repeat tests
- Display or save test results
- Run thorough tests to introduce additional test options to provide extra information about the failed device(s)

- View status messages that inform you if tests are completed successfully
- View error messages that inform you of problems encountered during testing

**i** **NOTE:** Some tests for specific devices require user interaction. Always ensure that you are present at the computer terminal when the diagnostic tests are performed.

For more information, see [Resolve Hardware Issues With Integrated and Online Diagnostics \(SupportAssist ePSA, ePSA, or PSA Error Codes\)](#).

## Running the SupportAssist Pre-Boot System Performance Check

### Steps

1. Turn on your computer.
2. As the computer boots, press the F12 key.
3. On the boot menu screen, select **Diagnostics**.  
The diagnostic quick test begins.  
**i** **NOTE:** For more information about running the SupportAssist Pre-Boot System Performance Check on a specific device, see [Dell Support Site](#).
4. If there are any issues, error codes are displayed.  
Note the error code and validation number and contact Dell.

## Built-in self-test (BIST)

### Motherboard Built-In Self-Test (M-BIST)

M-BIST is the system board onboard self-test diagnostics tool that improves the diagnostics accuracy of system board Embedded Controller (EC) failures.

**i** **NOTE:** M-BIST can be manually initiated before Power On Self-Test (POST).

### How to run M-BIST

**i** **NOTE:** Before initiating M-BIST, ensure that the computer is in a power-off state.

1. Press and hold both the **M** key and the power button to initiate M-BIST.
2. The battery-status light may exhibit two states:
  - Off: No fault was detected.
  - Amber and White: Indicates a problem with the system board.
3. If there is a failure with the system board, the battery-status light flashes one of the following error codes for 30 seconds:

**Table 42. LED error codes**

Blinking Pattern		Possible Problem
Amber	White	
2	1	CPU Failure
2	8	LCD Power Rail Failure
1	1	TPM Detection Failure
2	4	Memory/RAM failure

4. If there is no failure with the system board, the LCD cycles through the solid color screens (that are described in the LCD-BIST) for 30 seconds and then turn off.

## Logic Built-in Self-test (L-BIST)

L-BIST is an enhancement to the single LED error code diagnostics and is automatically initiated during POST. L-BIST will check the LCD power rail. If there is no power being supplied to the LCD (that is if the L-BIST circuit fails), the battery status LED flashes either an error code [2,8] or an error code [2,7].

 **NOTE:** If L-BIST fails, LCD-BIST cannot function as no power will be supplied to the LCD.

### How to invoke the L-BIST

1. Turn on your computer.
2. If the computer does not start up normally, look at the battery status LED:
  - If the battery status LED flashes an error code [2,7], the display cable may not be connected properly.
  - If the battery status LED flashes an error code [2,8], there is a failure on the LCD power rail of the system board, hence there is no power that is supplied to the LCD.
3. For cases, when a [2,7] error code is shown, check to see if the display cable is properly connected.
4. For cases when a [2,8] error code is shown, replace the system board.

## LCD Built-in Self-Test (LCD-BIST)

Dell laptops have a built-in diagnostic tool that helps you determine if the screen abnormality you are experiencing is an inherent problem with the LCD (screen) of the Dell laptop or with the video card (GPU) and computer settings.

When you notice screen abnormalities like flickering, distortion, clarity issues, fuzzy or blurry image, horizontal or vertical lines, color fade, it is always a good practice to isolate the LCD (screen) by running the LCD-BIST.

### How to invoke the LCD-BIST

1. Turn off your computer.
2. Disconnect any peripherals that are connected to the computer. Connect only the AC adapter (charger) to the computer.
3. Ensure that the LCD (screen) is clean (no dust particles on the surface of the screen).
4. Press and hold the **D** key and press the power button to enter LCD-BIST mode. Continue to hold the **D** key until the computer boots up.
5. The screen displays solid colors and changes colors on the entire screen to white, black, red, green, and blue twice.
6. Then it displays the colors white, black, and red.
7. Carefully inspect the screen for abnormalities (any lines, fuzzy color, or distortion on the screen).
8. At the end of the last solid color (red), the computer shuts down.

 **NOTE:** Dell SupportAssist Preboot diagnostics upon launch initiates an LCD-BIST first, expecting a user intervention to confirm functionality of the LCD.

## System-diagnostic lights

### Power and battery-status light

The power and battery status light indicates the power and battery status of the computer. These are the power states:

**Solid white:** Power adapter is connected and the battery has more than 5% charge.

**Amber:** Computer is running on battery and the battery has less than 5% charge.

#### Off:

- Power adapter is connected, and the battery is fully charged.
- Computer is running on battery, and the battery has more than 5% charge.
- Computer is in sleep state, hibernation, or turned off.

The power and battery-status light may blink amber or white according to pre-defined "beep codes" indicating various failures.

For example, the power and battery-status light blinks amber two times followed by a pause, and then blinks white three times followed by a pause. This 2,3 pattern continues until the computer is turned off, indicating no memory or RAM is detected.

The following table shows different power and battery-status light patterns and associated problems.

**NOTE:** The following diagnostic light codes and recommended solutions are intended for Dell service technicians to troubleshoot problems. You should only perform troubleshooting and repairs as authorized or directed by the Dell technical assistance team. Damage due to servicing that is not authorized by Dell is not covered by your warranty.

**Table 43. Diagnostic-light LED codes**

Blinking pattern		Problem description
Amber	White	
2	1	CPU failure
2	2	System board failure (included BIOS corruption or ROM error)
2	3	No memory/RAM detected
2	4	Memory/RAM failure
2	5	Invalid memory installed
2	6	System board/chipset error
2	7	LCD failure
2	8	LCD power rail failure
3	1	RTC power failure
3	2	PCI or video card/chip failure
3	3	BIOS Recovery image not found
3	4	BIOS Recovery image found but invalid
3	5	Power rail failure
3	6	SBIOS flash corruption
3	7	ME error

**NOTE:** Blinking 3-3-3 LEDs on Lock LED (Caps-Lock or Nums-Lock), Power button LED (without Fingerprint reader), and Diagnostic LED indicates failure to provide input during LCD panel test on Dell SupportAssist Pre-boot System Performance. Check diagnostics.

**Camera status light:** Indicates whether the camera is in use.

- Solid white—Camera is in use.
- Off—Camera is not in use.

**Caps Lock status light:** Indicates whether Caps Lock is enabled or disabled.

- Solid white — Caps Lock enabled.
- Off — Caps Lock disabled.

## Recovering the operating system

When your computer is unable to boot to the operating system even after repeated attempts, it automatically starts Dell SupportAssist OS Recovery.

Dell SupportAssist OS Recovery is a stand-alone tool that is preinstalled on Dell computers running the Windows operating system. It consists of tools to diagnose and troubleshoot issues that may occur before your computer boots to the operating system. It enables you to diagnose hardware issues, repair your computer, back up your files, and restore your computer to its factory state.

You can also download it from the Dell Support website to troubleshoot and fix your computer when it fails to boot into the primary operating system due to software or hardware failures.

For more information about the Dell SupportAssist OS Recovery, see *Dell SupportAssist OS Recovery User's Guide* at [Serviceability Tools at the Dell Support Site](#). Click **SupportAssist** and then click **SupportAssist OS Recovery**.

 **NOTE:** Windows 11 IoT Enterprise LTSC 2024 and Dell ThinOS 10 do not support Dell SupportAssist. For more information about recovering ThinOS 10, see [Recovery mode using R-Key](#).

## Real-Time Clock (RTC Reset)

The Real-Time Clock (RTC) reset function enables you or the service technician to recover Dell computers from No POST/No Power/No Boot situations.

Start the RTC reset with the computer powered off and connected to AC power. Press and hold the power button for twenty-five seconds. The computer RTC Reset occurs after you release the power button.

## Backup media and recovery options

It is recommended to create a recovery drive to troubleshoot and fix problems that may occur with Windows. Dell provides multiple options for recovering the Windows operating system on your Dell computer. For more information, see [Dell Windows Backup Media and Recovery Options](#).

## Network power cycle

### About this task

If your computer is unable to access the Internet due to network connectivity issues, reset your network devices by performing the following steps:

### Steps

1. Turn off the computer.
2. Turn off the modem.  
 **NOTE:** Some Internet service providers (ISPs) provide a modem and router combo device.
3. Turn off the wireless router.
4. Wait for 30 seconds.
5. Turn on the wireless router.
6. Turn on the modem.
7. Turn on the computer.

## Drain flea power (perform hard reset)

### About this task

Flea power is the residual static electricity that remains in the computer even after it has been powered off and the battery is removed.

For your safety, and to protect the sensitive electronic components in your computer, you must drain residual flea power before removing or replacing any components in your computer.

Draining flea power, also known as performing a "hard reset," is also a common troubleshooting step if your computer does not turn on or boot into the operating system.

Perform the following steps to drain the flea power:



## Steps

1. Turn off the computer.
2. Disconnect the power adapter from the computer.
3. Remove the base cover.
4. Remove the battery.

 **CAUTION: The battery is a Field Replaceable Unit (FRU) and the removal and installation procedures are intended for authorized service technicians only.**

5. Press and hold the power button for 20 seconds to drain the flea power.
6. Install the battery.
7. Install the base cover.
8. Connect the power adapter to the computer.
9. Turn on the computer.

 **NOTE:** For more information about performing a hard reset, go to [Dell Support Site](#). On the menu bar at the top of the Support page, select Support > Support Library. In the Search field on the Support Library page, type the keyword, topic, or model number, and then click or tap the search icon to view the related articles.

# Getting help and contacting Dell

## Self-help resources

You can get information and help on Dell products and services using these self-help resources:

**Table 44. Self-help resources**

Self-help resources	Resource location
Information about Dell products and services	<a href="#">Dell Site</a>
Contact Support	In Windows search, type <code>Contact Support</code> , and press Enter.
Online help for operating system	<a href="#">Windows Support Site</a> <a href="#">Linux Support Site</a>
Access top solutions, diagnostics, drivers and downloads, and learn more about your computer through videos, manuals, and documents.	Your Dell computer is uniquely identified using a Service Tag or Express Service Code. To view relevant support resources for your Dell computer, enter the Service Tag or Express Service Code at <a href="#">Dell Support Site</a> .  For more information about how to find the Service Tag for your computer, see <a href="#">Locate the Service Tag on your computer</a> .
Dell knowledge base articles	<ol style="list-style-type: none"> <li>1. Go to <a href="#">Dell Support Site</a>.</li> <li>2. On the menu bar at the top of the Support page, select <b>Support &gt; Support Library</b>.</li> <li>3. In the Search field on the Support Library page, type the keyword, topic, or model number, and then click or tap the search icon to view the related articles.</li> </ol>

## Contacting Dell

To contact Dell for sales, technical support, or customer service issues, see [Dell Support Site](#).

 **NOTE:** Availability of the services may vary depending on the country or region, and product.

 **NOTE:** If you do not have an active Internet connection, you can find contact information in your purchase invoice, packing slip, bill, or Dell product catalog.

# Revision history

Tracks all updates that are made to the document. It typically includes the date of change, version number, and a brief description of the modification. This log helps maintain transparency, accountability, and a clear timeline of progress.

**Table 45. Revision history**

<b>Revision</b>	<b>Date</b>	<b>Description</b>
A00	08-29-2025	Original publish date.